

# SCHATTTELLO



**ShadeZone**  
Alfresco Specialists

This is the classic and proven gastronomy parasol made by MAY. Thousands of customers appreciate its stability, durability and variety. Multiple sizes allow various combinations for an optimal shading of your terrace. You would like to please your guests on a hot summer's day by offering them a welcoming seat outdoors in the cool shade? Or to charm them on a nippy day or a chilly night by conjuring up a cosy atmosphere with dimmed lights and comfortable heating? Then our strong but graceful SCHATTELLO is what you are looking for. The maintenance-free gearbox is designed for ultra-easy handling, even after many years of outdoor use in any weather.



## SOLID

### LARGE PARASOL

- For professional gastronomy
- All-weather protection
- Easy operation
- Professional additional equipment



SCHATTELLO 4.0 x 4.0 m  
MayTex-Acryl SA 314 038 beige





SCHATTELLO 5.0 x 5.0 m  
MayTex-Acryl SA 314 347 ruby



You will find our product video at: [may.ag/s\\_en](http://may.ag/s_en)

### Frame joints

For us perfection in workmanship is an absolute must. Therefore, all moving axes are fitted with easily removable bolts. This extravagant technology ensures maximum stability and durability as well as easy execution of repairs.

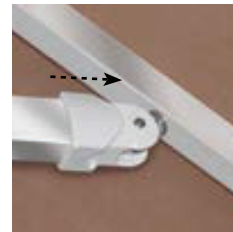

### Top plate

Elegant and graceful. Can be screwed off. Colour to match frame.

### Canopy options

This optional, decorative textile bonnet for the top of the parasol canopy gives a feeling of airy, Mediterranean stylishness.



Canopy bonnet



### Central rod system

The robust parasol central rod system consists of two discs with support struts and spokes. In order to prevent the spokes from twisting, the lower distribution flange is firmly welded to the support pole. The frame is made of high-quality, alloyed, extruded aluminium profiles.

- support pole Ø 76 x 3 mm
- spoke dimensions 35 x 20 x 2 mm
- support strut dimensions 30 x 20 x 2 mm

### Valance options



Straight valance

Without valance



### Operating the parasol

SCHATTELLO, our giant parasol, is opened and closed with a smooth-running, removable stainless steel crank or with the help of a cordless drill (hex drill fitting). The reliable drive-system with accurate integrated bevel gears guarantees effortless handling, even after years of usage. For a more convenient operation the giant parasol can be equipped with a tabular motor at extra charge.



### Canopy covering

Due to a special self-tensioning telescopic spring system the colour remains perfectly taut, even after years of usage. The canopy covering can easily and quickly be exchanged by means of a practical hooking system. For fabrics and colours see page 194 onwards.



### High-quality framework materials

Frame surface is powder-coated, highly shock and impact-proof, available in following colours:



Standard colours:

- RAL 9010 pure white
- RAL 9006 white aluminium

Special colours, no extra charge:

- RAL 8019 greybrown
- RAL 7016 anthracite grey fine structure

Special colours available on request.

### Installation options

Mobile see page 106 onwards, stationary see page 110 onwards.

### Wind tunnel tested

We were able to prove the stability and sturdiness of our parasols during various tests in a wind tunnel. Even wind speeds of 50 km/h could not do any harm to a parasol of Ø 5 m. However, stability can only be guaranteed if the pedestal frame is adequately weighed down for the wind conditions of the intended location.

### When not in use

The protective cover provided can easily be slipped over the parasol during bad weather periods.

### Mounting

Pull parasol from cardboard sleeve, remove all packaging material, place parasol mast in installation base, that's all – ready for use in a jiffy!

### Additional equipment

Side sheets see page 192 onwards, rain gutter see page 88 onwards, premium equipment see page 178 onwards.







**\*NEW!**

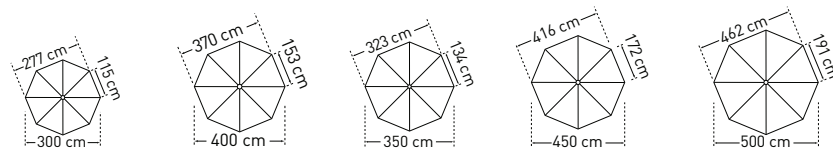

**\*NEW!**

**\*NEW!**

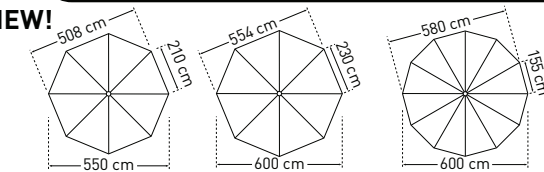

SCHATTELLO round		Ø 3.0 m	Ø 3.5 m	Ø 4.0 m	Ø 4.5 m	Ø 5.0 m
Segments		8	8	8	8	8
Area	m <sup>2</sup>	6.4	8.7	11.3	14.3	17.7
<b>A</b>	Height closed incl. top plate	cm	355	366	410	427
<b>B</b>	Height opened incl. top plate	cm	304	302	303	317
<b>C</b>	Headroom with valance	cm	212	212	202	212
<b>D</b>	Headroom without valance from spoke edge	cm	237	237	227	237
<b>F</b>	Ground clearance from spoke edge	cm	193	182	193	187
<b>G</b>	Height of lower disc flange	cm	227	225	183	203
	Weight without packaging MayTex-Acryl without valance	kg	26	28	33	34
	Support pole diameter	mm	outer-Ø 76, pole thickness 3			
	Packaging cardboard sleeve: length 444 cm		Ø 33 cm approx. 17 kg			
	Installation base length/width/min. depth	cm	50/50/60			
	Minimum-ballast Number of layers of concrete slabs XZ50 required		1 x = approx. 112 kg			

SCHATTELLO round		Ø 5.5 m	Ø 6.0 m	Ø 6.0 m
Segments		8	8	12
Area	m <sup>2</sup>	21.4	25.5	27
<b>A</b>	Height closed incl. top plate	cm	435	440
<b>B</b>	Height opened incl. top plate	cm	319	333
<b>C</b>	Headroom with valance	cm	212	197
<b>D</b>	Headroom without valance from spoke edge	cm	237	222
<b>F</b>	Ground clearance from spoke edge	cm	145	123
<b>G</b>	Height of lower disc flange	cm	204	213
	Weight without packaging MayTex-Acryl without valance	kg	39	46
	Support pole diameter	mm	outer-Ø 76, pole thickness 3	
	Packaging cardboard sleeve: length 444 cm		Ø 33 cm approx. 17 kg	Ø 35 cm approx. 18 kg
	Installation base length/width/min. depth	cm	50/50/60	60/60/60
	Minimum-ballast Number of layers of concrete slabs XZ50 required		1 x = approx. 112 kg	2 x = approx. 224 kg

The heights specified are for parasols with MayTex-Acryl covering fabric that are mounted in an anchor tube (SZ118, SZ146, SZ150). The increase in height for parasols with other installation bases can be seen in the list below:

- Full frame pedestal: SZ201 + 14 cm
- Full frame pedestal: SZ203 + 17 cm
- Full frame pedestal: SZ205 + 21 cm
- Full frame pedestal: SZ411 + 9 cm
- Full frame pedestal: SZ412 + 12 cm
- Full frame pedestal: SZ414 + 16 cm
- Full frame pedestal: SZ420 + 19 cm
- Anchor plate: SZ131 + 1.5 cm
- Anchor plate: SZ261 + 1.5 cm
- Base plate: SZ272 + 4 cm
- Base plate: SZ273 + 4 cm
- Base plate: SZ274 + 4 cm
- Base plate: SZ275 + 4 cm

3D view of installation base with top plate for winter protection. Base must be frost-proof and enlarged if the ground is unstable.

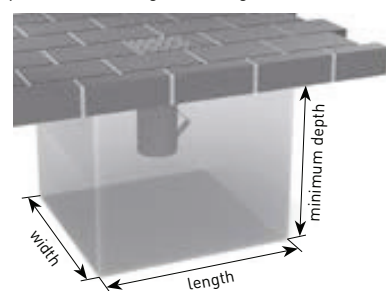

Intermediate and special sizes on request. Dimensional tolerance approx. 5%.

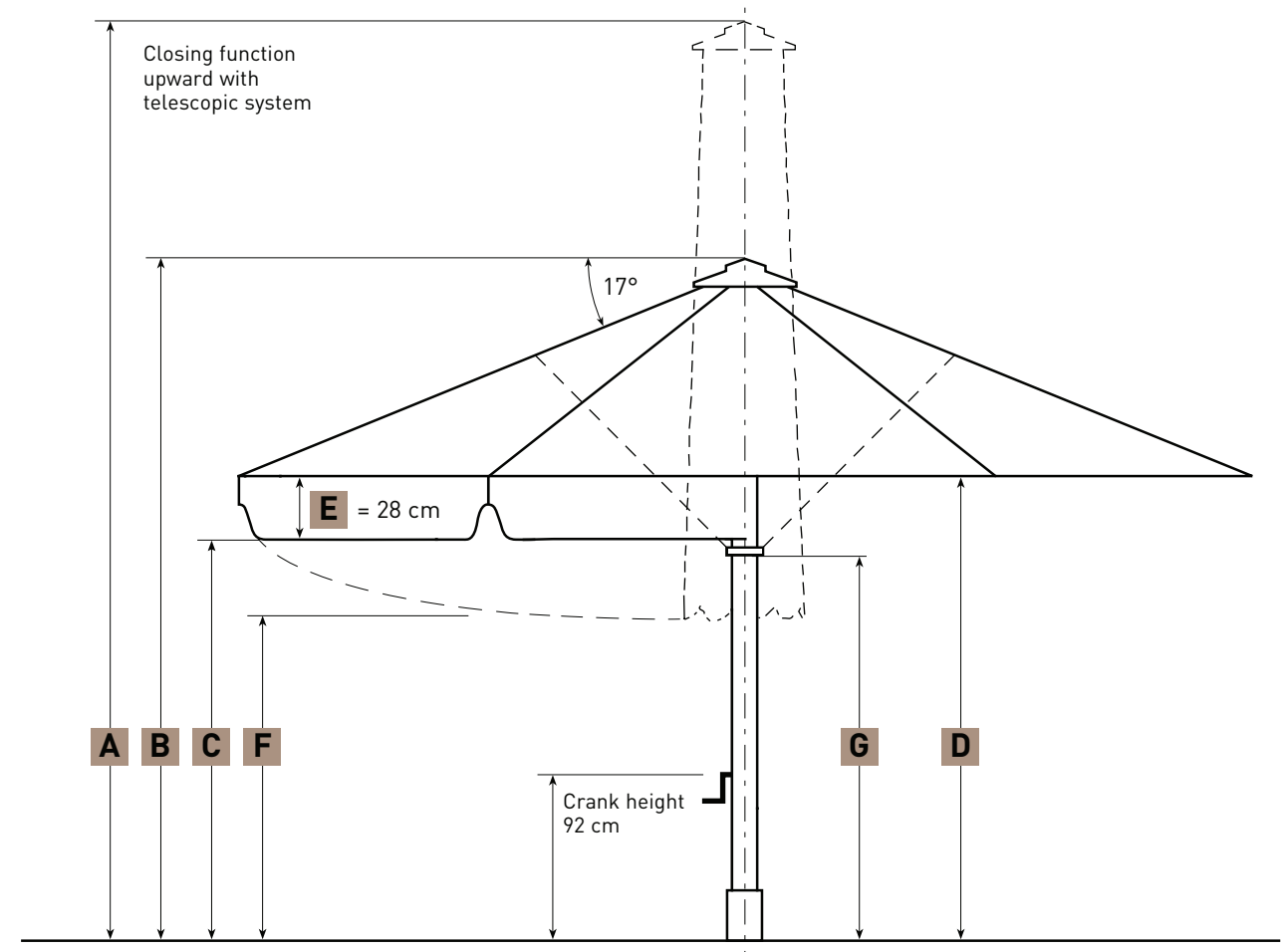



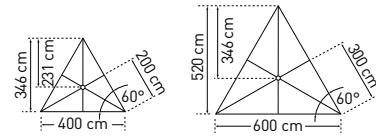

SCHATTELLO triangular		4 x 4 x 4 m	6 x 6 x 6 m
	Segments	6	6
	Area	m <sup>2</sup> 6.9	15.6
<b>A</b>	Height closed incl. top plate	cm 391	402
<b>B</b>	Height opened incl. top plate	cm 284	295
<b>C</b>	Headroom with valance	cm 212	212
<b>D</b>	Headroom without valance from spoke edge	cm 237	237
<b>F</b>	Ground clearance from spoke edge	cm 153	51
<b>G</b>	Height of lower disc flange	cm 234	183
	Weight without packaging MayTex-Acryl without valance	kg 27	40
	Support pole diameter	mm outer-Ø 76, pole thickness 3	
	Packaging cardboard sleeve: length 444 cm	Ø 33 cm approx. 17 kg	
	Installation base length/width/min. depth	cm 50/50/60	
	Minimum-ballast Number of layers of concrete slabs XZ50 required	1 x = approx. 112 kg	



SCHATTELLO 6.0 x 6.0 x 6.0 m  
MayTex-Acryl SA 314 546 blue patina  
without valance

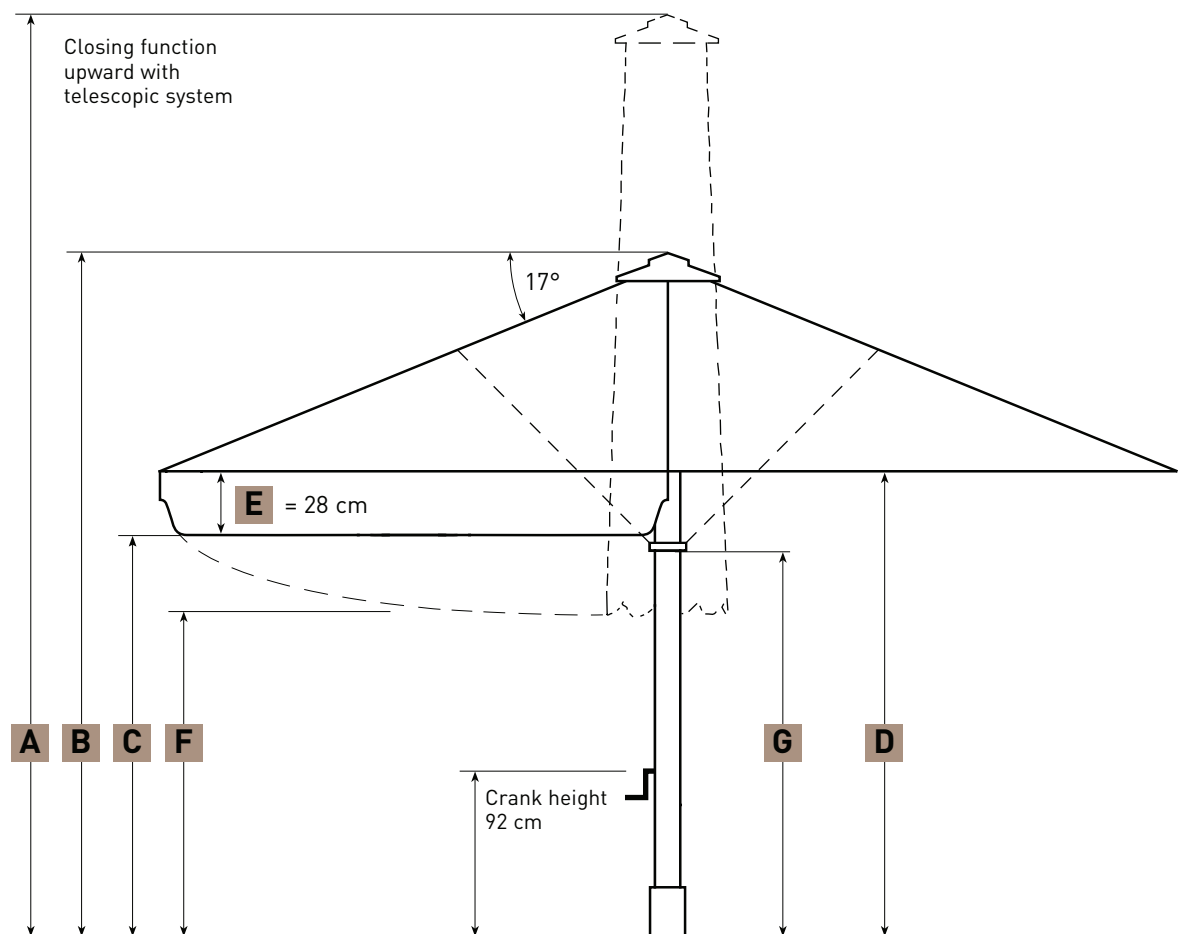

straight valance





SCHATTELLO 3.5 x 3.5 m  
MayTex-Acryl SA 314 010 white  
without valance



straight valance



continuous valance



SCHATTELLO 4.5 x 4.5 m  
MayTex-Acryl DA 8203 grey basalt  
without valance



straight valance



continuous valance



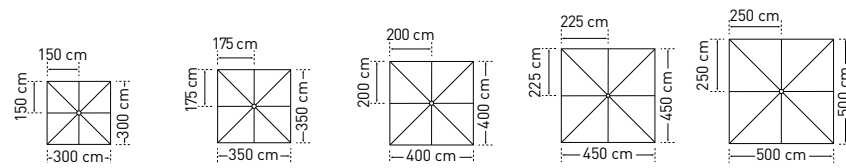

SCHATTELLO square		3.0 x 3.0 m	3.5 x 3.5 m	4.0 x 4.0 m	4.5 x 4.5 m	5.0 x 5.0 m	
Segments		8	8	8	8	8	
Area	m <sup>2</sup>	9	12.3	16	20.3	25	
<b>A</b>	Height closed incl. top plate	cm	410	418	425	433	440
<b>B</b>	Height opened incl. top plate	cm	300	308	315	323	330
<b>C</b>	Headroom with valance	cm	212	212	212	212	212
<b>D</b>	Headroom without valance from spoke edge	cm	237	237	237	237	237
<b>F</b>	Ground clearance from spoke edge	cm	180	154	119	96	62
<b>G</b>	Height of lower disc flange	cm	252	190	198	203	213
	Weight without packaging MayTex-Acryl without valance	kg	31	35	39	41	43
	Support pole diameter	mm	outer-Ø 76, pole thickness 3				
	Packaging cardboard sleeve: length 444 cm		Ø 33 cm approx. 17 kg				
	Installation base length/width/min. depth	cm	50/50/60			60/60/60	
	Minimum-ballast Number of layers of concrete slabs XZ50 required		1 x = approx. 112 kg			2 x = approx. 224 kg	

The heights specified are for parasols with MayTex-Acryl covering fabric that are mounted in an anchor tube (SZ118, SZ146, SZ150). The increase in height for parasols with other installation bases can be seen in the list below:

- Full frame pedestal: SZ201 + 14 cm
- Full frame pedestal: SZ203 + 17 cm
- Full frame pedestal: SZ205 + 21 cm
- Full frame pedestal: SZ411 + 9 cm
- Full frame pedestal: SZ412 + 12 cm
- Full frame pedestal: SZ414 + 16 cm
- Full frame pedestal: SZ420 + 19 cm
- Anchor plate: SZ131 + 1.5 cm
- Anchor plate: SZ261 + 1.5 cm
- Base plate: SZ272 + 4 cm
- Base plate: SZ273 + 4 cm
- Base plate: SZ274 + 4 cm
- Base plate: SZ275 + 4 cm

3D view of installation base with top plate for winter protection. Base must be frost-proof and enlarged if the ground is unstable.

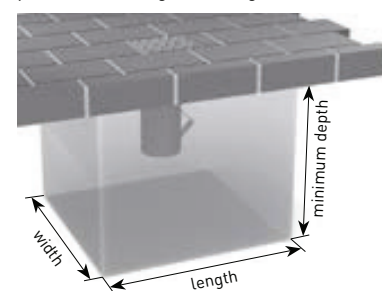

Intermediate and special sizes on request.  
Dimensional tolerance approx. 5%.



SCHATTELLO 4.0 x 4.0 m  
MayTex-Acryl SA 314 325 ecru





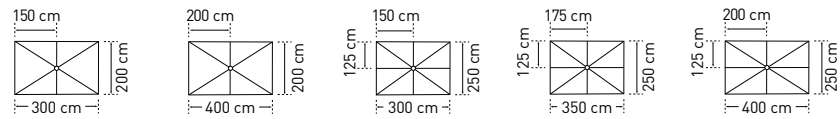

SCHATTELLO rectangular		2.0 x 3.0 m	2.0 x 4.0 m	2.5 x 3.0 m	2.5 x 3.5 m	2.5 x 4.0 m
Segments		6	6	8	8	8
Area	m <sup>2</sup>	6	8	7.5	8.8	10
<b>A</b>	Height closed incl. top plate	cm	383	387	399	397
<b>B</b>	Height opened incl. top plate	cm	277	280	301	298
<b>C</b>	Headroom with valance	cm	212	212	212	212
<b>D</b>	Headroom without valance from spoke edge	cm	237	237	237	237
<b>F</b>	Ground clearance from spoke edge	cm	202	152	193	175
<b>G</b>	Height of lower disc flange	cm	232	237	246	243
Weight without packaging	kg	27	26	27	29.5	30.5
Support pole diameter	mm	outer-Ø 76, pole thickness 3				
Packaging	cardboard sleeve: length 444 cm	Ø 33 cm approx. 17 kg				
Installation base	length/width/min. depth	50/50/60				
Minimum-ballast	Number of layers of concrete slabs XZ50 required	1 x = approx. 112 kg				

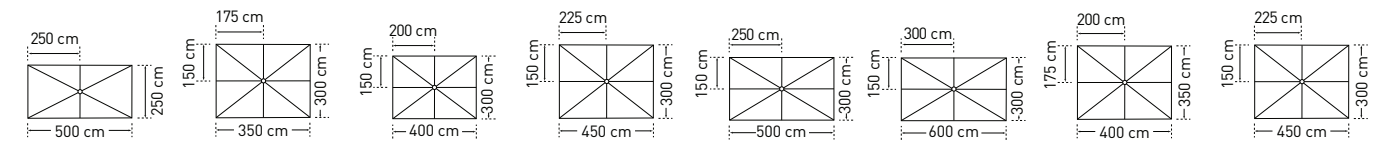

		2.5 x 5.0 m	3.0 x 3.5 m	3.0 x 4.0 m	3.0 x 4.5 m	3.0 x 5.0 m	3.0 x 6.0 m	3.5 x 4.0 m	3.5 x 4.5 m
		6	8	8	8	8	8	8	8
		12.5	10.5	12	13.5	15	18	14	15.8
<b>A</b>		397	402	397	405	397	405	410	415
<b>B</b>		298	305	298	298	290	298	303	308
<b>C</b>		212	212	212	212	212	212	212	212
<b>D</b>		237	237	237	237	237	237	237	237
<b>F</b>		107	160	135	124	97	63	135	117
<b>G</b>		243	250	245	203	245	190	187	230
		31	30.5	31	32	35	43	35	40
		outer-Ø 76, pole thickness 3							
		Ø 33 cm approx. 17 kg							
		50/50/60							
		1 x = approx. 112 kg							

The heights specified are for parasols with MayTex-Acryl covering fabric that are mounted in an anchor tube (SZ118, SZ146, SZ150). The increase in height for parasols with other installation bases can be seen in the list below:

- Full frame pedestal: SZ201 + 14 cm
- Full frame pedestal: SZ203 + 17 cm
- Full frame pedestal: SZ205 + 21 cm
- Full frame pedestal: SZ411 + 9 cm
- Full frame pedestal: SZ412 + 12 cm
- Full frame pedestal: SZ414 + 16 cm
- Full frame pedestal: SZ420 + 19 cm
- Anchor plate: SZ131 + 1.5 cm
- Anchor plate: SZ261 + 1.5 cm
- Base plate: SZ272 + 4 cm
- Base plate: SZ273 + 4 cm
- Base plate: SZ274 + 4 cm
- Base plate: SZ275 + 4 cm

3D view of installation base with top plate for winter protection. Base must be frost-proof and enlarged if the ground is unstable.

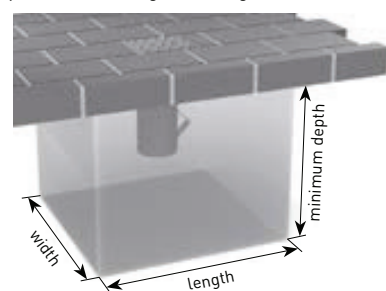

Intermediate and special sizes on request. Dimensional tolerance approx. 5%.

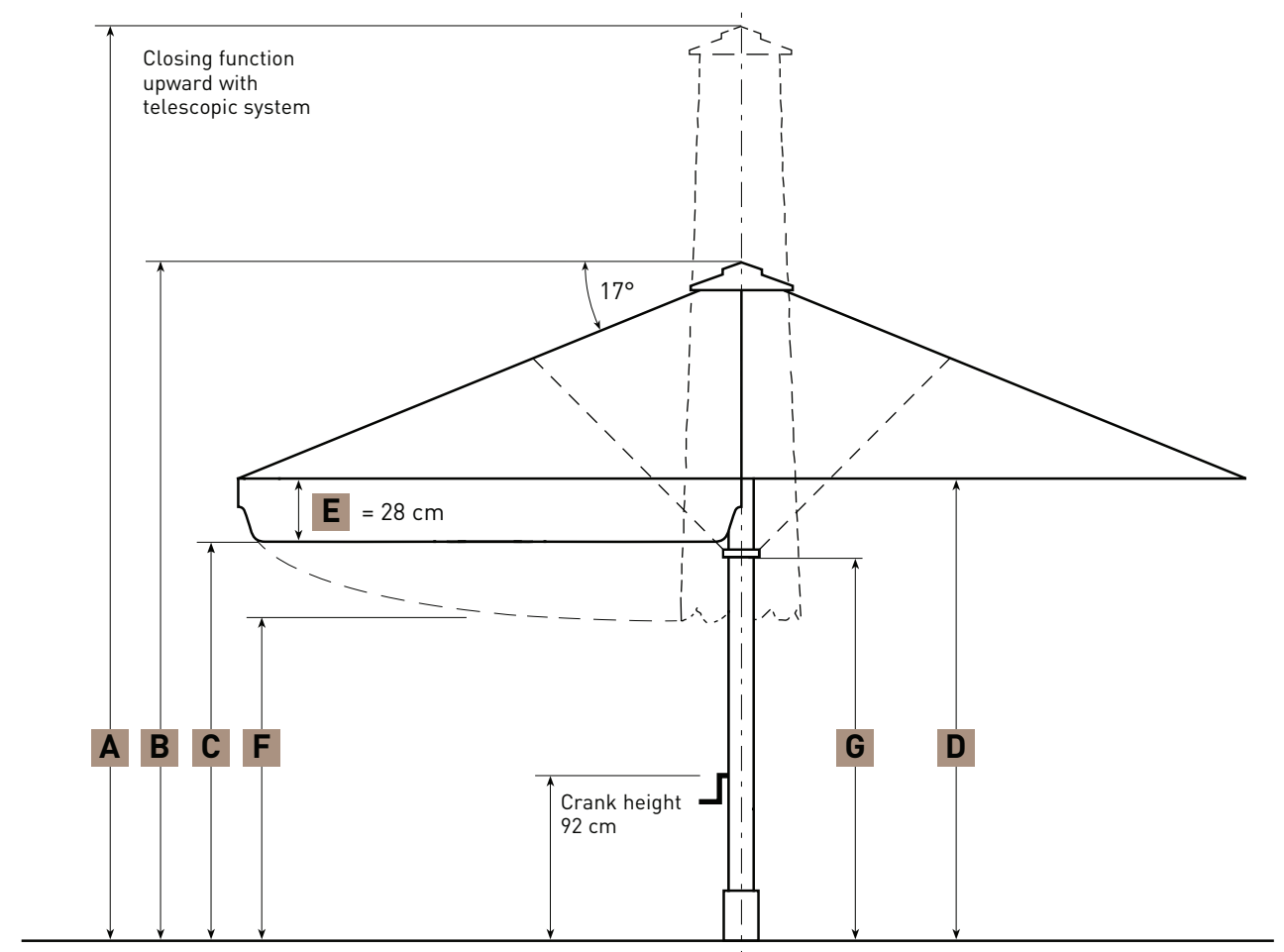



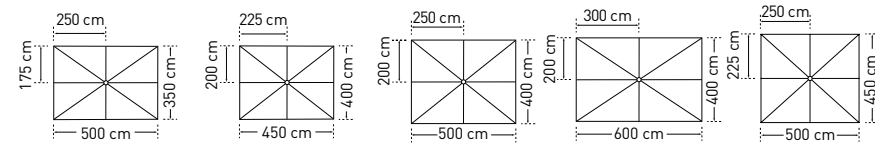

SCHATTELLO rectangular		3.5 x 5.0 m	4.0 x 4.5 m	4.0 x 5.0 m	4.0 x 6.0 m	4.5 x 5.0 m
Segments		8	8	8	8	8
Area		m <sup>2</sup> 17.5	18	20	24	22.5
<b>A</b>	Height closed incl. top plate	cm 420	416	420	425	425
<b>B</b>	Height opened incl. top plate	cm 313	293	313	318	313
<b>C</b>	Headroom with valance	cm 212	212	212	212	212
<b>D</b>	Headroom without valance from spoke edge	cm 237	237	237	237	237
<b>F</b>	Ground clearance from spoke edge	cm 105	105	84	54	84
<b>G</b>	Height of lower disc flange	cm 230	225	198	203	235
Weight without packaging MayTex-Acryl without valance		kg 41	41	43	46	44
Support pole diameter		mm outer-Ø 76, pole thickness 3				
Packaging cardboard sleeve: length 444 cm		mm Ø 33 cm approx. 17 kg				
Installation base length/width/min. depth		cm 50 / 50 / 60			60 / 60 / 60	
Minimum-ballast Number of layers of concrete slabs XZ50 required		1x = approx. 112 kg			2x = approx. 224 kg	

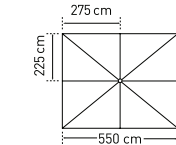

SCHATTELLO rectangular		4.5 x 5.5 m
Segments		8
Area		m <sup>2</sup> 24.8
<b>A</b>	Height closed incl. top plate	cm 423
<b>B</b>	Height opened incl. top plate	cm 312
<b>C</b>	Headroom with valance	cm 212
<b>D</b>	Headroom without valance from spoke edge	cm 237
<b>F</b>	Ground clearance from spoke edge	cm 64
<b>G</b>	Height of lower disc flange	cm 235
Weight without packaging MayTex-Acryl without valance		kg 51
Support pole diameter		mm outer-Ø 76
Packaging cardboard sleeve: length 444 cm		mm Ø 33 cm approx. 17 kg
Installation base length/width/min. depth		cm 60 / 60 / 60
Minimum-ballast Number of layers of concrete slabs XZ50 required		2x = approx. 224 kg

The heights specified are for parasols with MayTex-Acryl covering fabric that are mounted in an anchor tube (SZ118, SZ146, SZ150). The increase in height for parasols with other installation bases can be seen in the list below:

- Full frame pedestal: SZ201 + 14 cm
- Full frame pedestal: SZ203 + 17 cm
- Full frame pedestal: SZ205 + 21 cm
- Full frame pedestal: SZ411 + 9 cm
- Full frame pedestal: SZ412 + 12 cm
- Full frame pedestal: SZ414 + 16 cm
- Full frame pedestal: SZ420 + 19 cm
- Anchor plate: SZ131 + 1.5 cm
- Anchor plate: SZ261 + 1.5 cm
- Base plate: SZ272 + 4 cm
- Base plate: SZ273 + 4 cm
- Base plate: SZ274 + 4 cm
- Base plate: SZ275 + 4 cm

3D view of installation base with top plate for winter protection. Base must be frost-proof and enlarged if the ground is unstable.

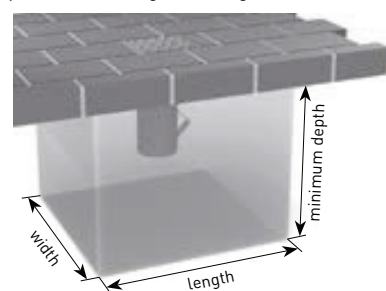

Intermediate and special sizes on request.  
Dimensional tolerance approx. ± 5%

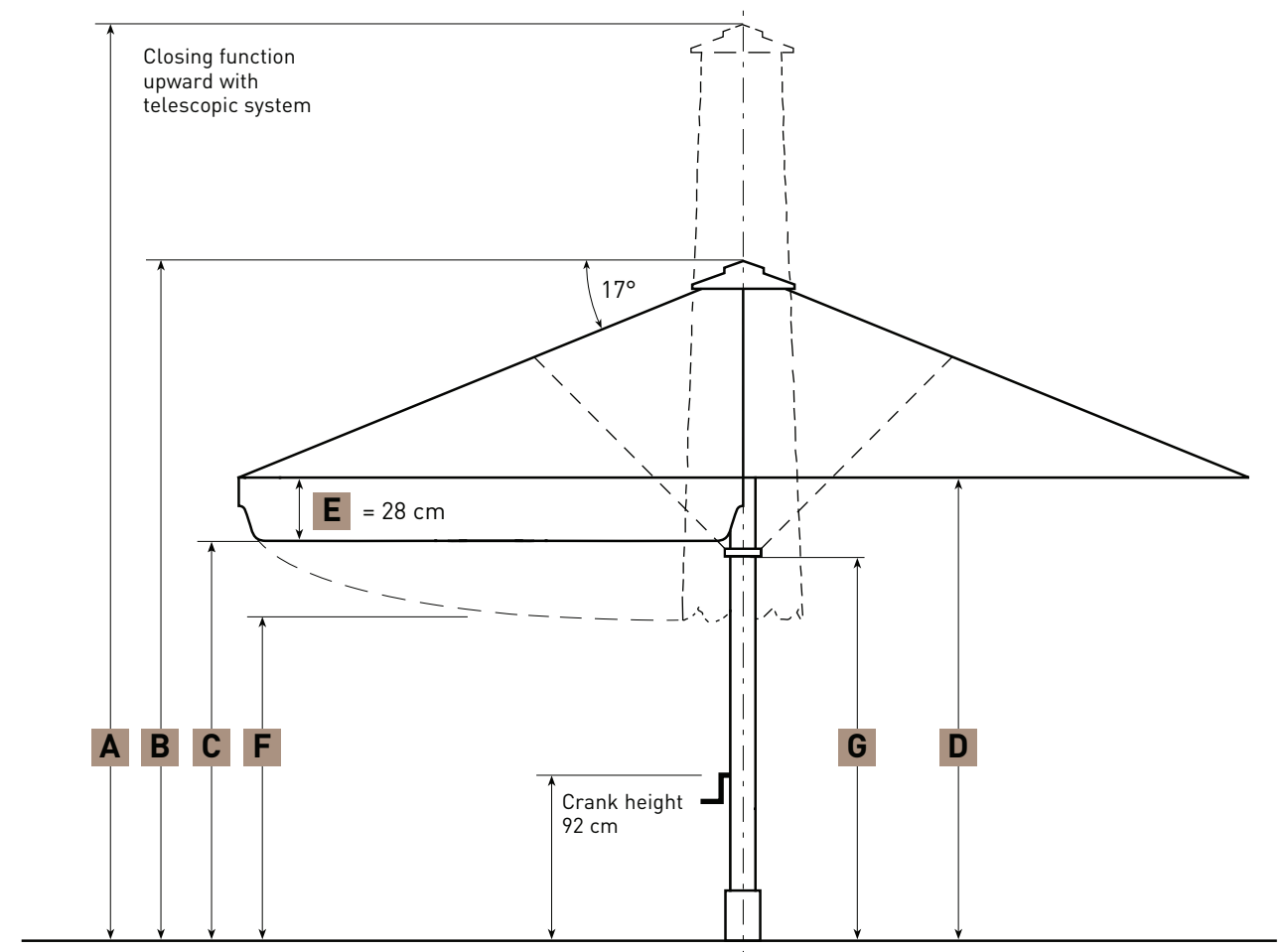

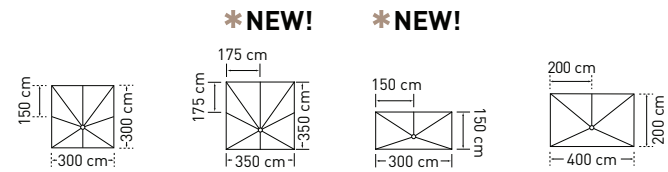

SCHATTELLO eccentric			3.0 x 3.0 m	3.5 x 3.5 m	1.5 x 3.0 m	2.0 x 4.0 m
X	Distance from centre pole to outer edge of canopy	cm	100	100	50	70
	Segments		8	8	5	5
	Area	m <sup>2</sup>	9	12.25	4.5	8
A	Height closed incl. top plate	cm	391	388	370	370
B	Height opened incl. top plate	cm	305	324	276	293
C	Headroom with valance	cm	212	212	212	212
D	Headroom without valance from spoke edge	cm	237	237	237	237
F	Ground clearance from spoke edge	cm	144	68	181	140
G	Height of lower disc flange	cm	250	247	231	246
J		cm	193	122	260	248
K		cm	232	178		
L		cm	213	169	207	169
M		cm	288	257		
	Weight without packaging MayTex-Acryl without valance	kg	37	37	21	27
	Support pole diameter	mm	outer-Ø 76, pole thickness 3			
	Packaging cardboard sleeve: length 444 cm		Ø 33 cm approx. 17 kg			
	Installation base length/width/min. depth	cm	50 / 50 / 60			
	Minimum-ballast Number of layers of concrete slabs XZ50 required		2 x = approx. 224 kg			

		3.0 x 4.0 m
X	Distance from centre pole to outer edge of canopy	100
	Segments	8
	Area	12
A	Height closed incl. top plate	410
B	Height opened incl. top plate	300
C	Headroom with valance	212
D	Headroom without valance from spoke edge	237
F	Ground clearance from spoke edge	118
G	Height of lower disc flange	263
J		197
K		192
L		175
M		293
	Weight without packaging MayTex-Acryl without valance	36
	Support pole diameter	outer-Ø 76, pole thickness 3
	Packaging cardboard sleeve: length 444 cm	Ø 33 cm approx. 17 kg
	Installation base length/width/min. depth	50 / 50 / 60
	Minimum-ballast Number of layers of concrete slabs XZ50 required	2 x = approx. 224 kg

The heights specified are for parasols with MayTex-Acryl covering fabric that are mounted in an anchor tube SZ150. The increase in height for eccentric parasols with other installation bases can be seen in the list below:

- Full frame pedestal: SZ203 + 17 cm
- Full frame pedestal: SZ412 + 12 cm
- Anchor plate: SZ131 + 1.5 cm
- Base plate: SZ273 + 4 cm
- Base plate: SZ275 + 4 cm

Dimensional tolerance approx. ± 5%

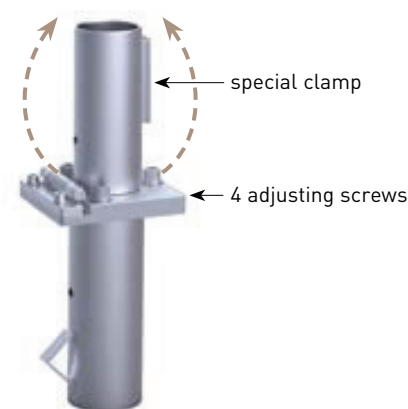

SZ150 with alignment possibility + special clamp

### Alignment possibility + special clamp

It is only possible to use such installation bases for SCHATTELLO parasols that have a locking hinge or a full-frame pedestal, adjustable for slanting surfaces. Anchoring bases with locking hinge are installed with setscrews and a special surface clamp. This ensures that the eccentric parasol will be aligned and mounted completely upright.

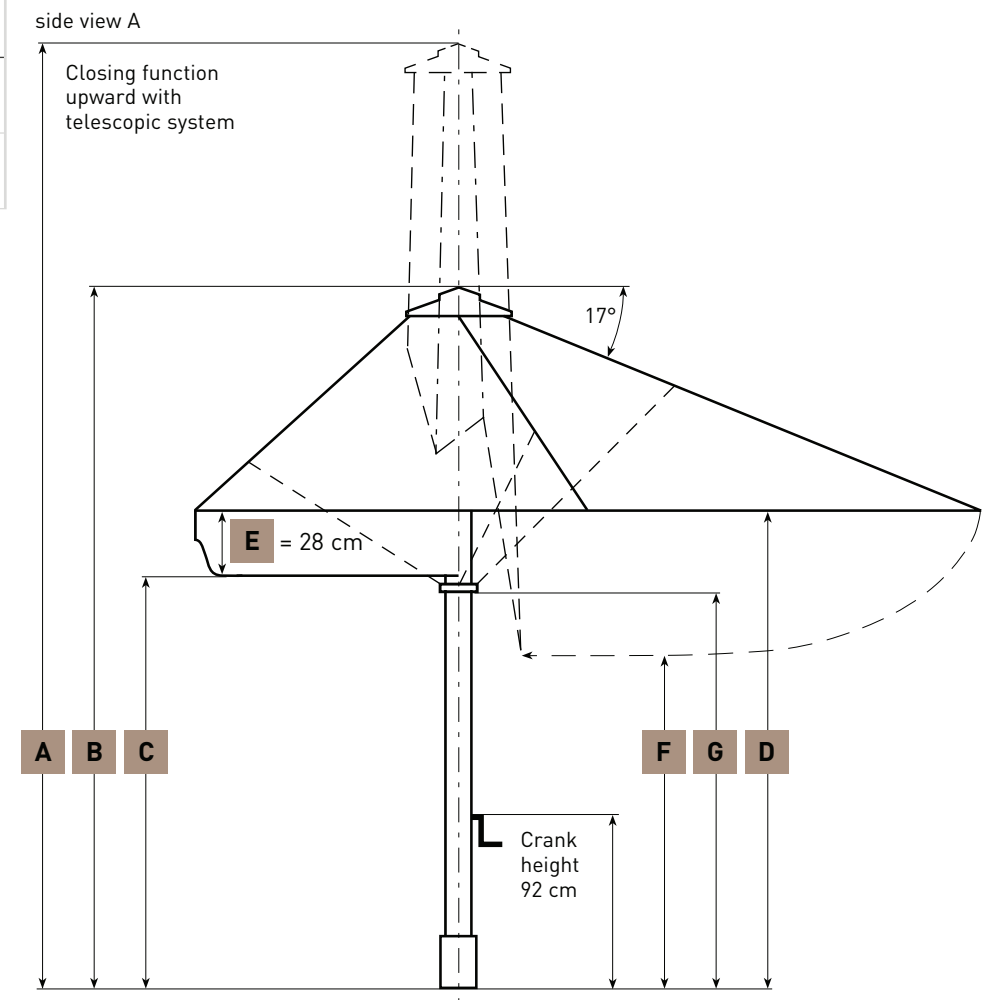



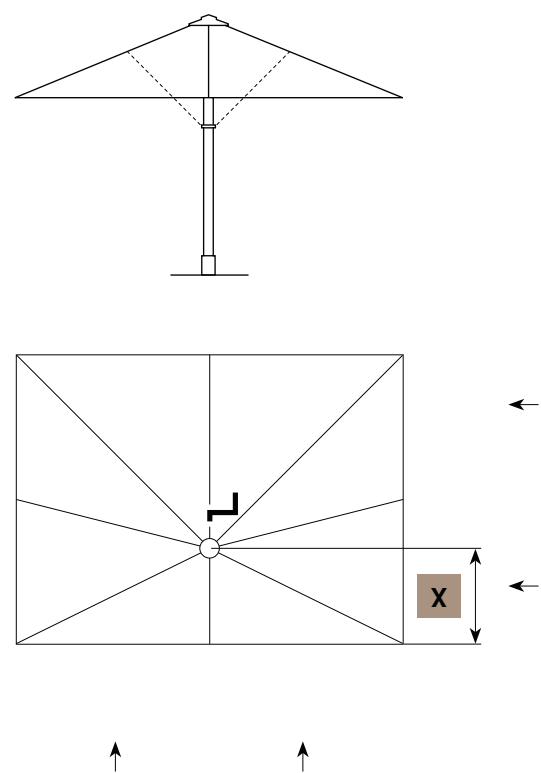
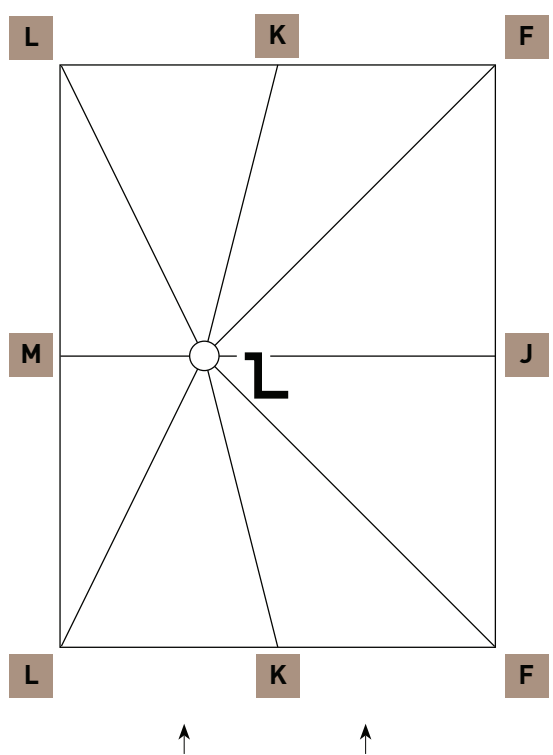





canopy bonnet and base plate SZ273  
 SCHATTELLO 4.5 x 4.5 m  
 MayTex-Acryl DA 7560 light yellow



**Canopy bonnet**

A light bonnet in the centre of the canopy optically breaks the straight areas and lines. This gives the SCHATTELLO a complete new face. The overlapping between canopy bonnet and canopy ensures that as few as possible water enters the openings in case of rain and wind. So there are hardly any limitations of the regular functions. Available for all sizes (except parasols with continuous roof segments).



**Seawater-resistant stainless steel connections**

To allow the use of the SCHATTELLO directly at the coast nearby salty sea water, rustproof materials must be used. With this package all turned and standard parts are supplied in stainless steel V4A (1.4401, AISI 316). Optimal protection for minimal oxidation of the aluminium frame.

art. no. **350118**

**Protective sleeve, version bag**

made of tarp material, colour grey. Please specify parasol size or serial number. Included in delivery of parasol.

art. no. **SA130**



**Protective sleeve, version zipper**

with zipper and rope, without telescopic pole, art. no. 356040; made of tarp material, colour grey. May also be used for parasols with heaters, if they are demounted (winter storage). Please specify parasol size or serial number.

art. no. **SA122**



**Protective sleeve, version zipper for parasols with integrated heaters**

with zipper and rope, without telescopic pole, art. no. 356040; made of tarp material, colour grey. For daily protection of your parasols with mounted heaters. Please specify parasol size or serial number.

art. no. **SA124**



**\* NEW!**

**Telescopic pole**

maximum length 4.5 m, without ring. For retrofit of all protective sleeves with zipper. No ladder required for pulling on the protective sleeve. One piece per terrace needed.

art. no. **356040**





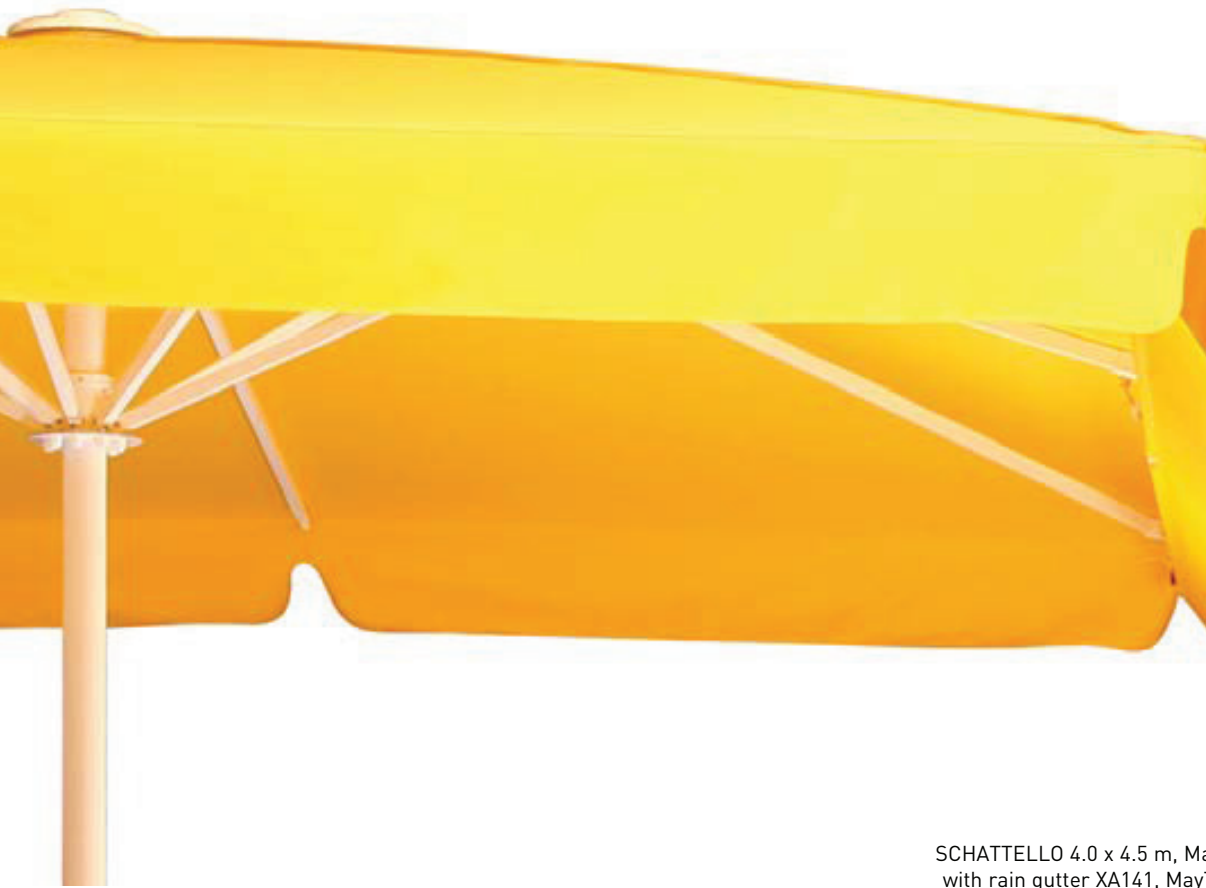

SCHATTELLO 4.0 x 4.5 m, MayTex-Acryl SA 314 003 yellow with rain gutter XA141, MayTex-Poly M 9526 bright yellow



SCHATTELLO 4.0 x 4.5 m, MayTex-Acryl SA 314 003 yellow with suspended rain gutter, MayTex-Poly M 9526 bright yellow



**Rain gutter**  
in MayTex-Poly or MayTex-PVC, with aluminium rods for stabilization.  
Can only be used with valance.  
art. no. **XA141**

**Holder for suspended rain gutter**  
made from aluminium and stainless steel,  
1 piece per spoke required.

with 1 eyelet screw and  
1 stainless steel angle, left

art. no. **SA150**

with 1 eyelet screw and  
1 stainless steel angle, right

art. no. **SA151**

with 2 eyelet screw and  
2 stainless steel angles

art. no. **SA152**

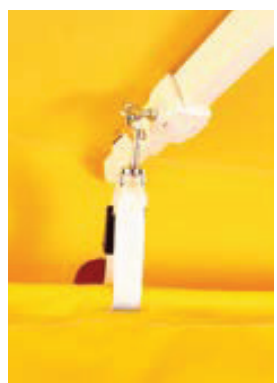

**Glass-fibre reinforced plastic holder for side sheet and rain gutter**  
1 piece per spoke required.  
with 1 eyelet screw art. no. **SA141 01**  
with 2 eyelet screws art. no. **SA141 02**

**Length extension of centre pole**  
State required additional length in cm (max. 50 cm).

**Shortening of centre pole**  
Length on request, dependent on parasol size.

**Frame paint finish**  
Please state colour of powder-coating in RAL.

**Canopy covering MayTex-PVC**  
approx. 480 g/m<sup>2</sup> ± 5%.

**Side sheets**  
Textile in MayTex-Poly, see page 192 onwards.

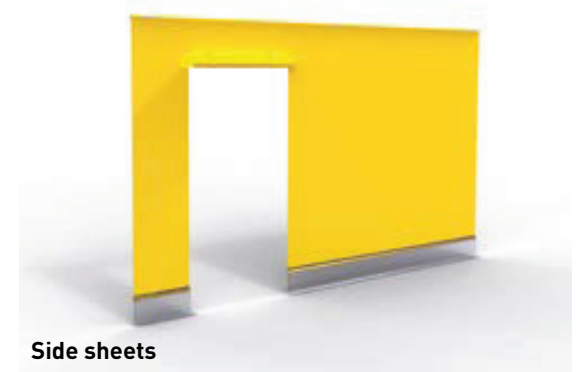

Side sheets





## PLAY-SCHOOL PARASOL



Example of a playschool parasol

### Special model: Playschool parasol Ø 5 m

The colourful, multi-design canopy coverings consist of different, randomly selected segments. Thus each parasol is unique and offers fun and variety on any kids' playground. Only available in size Ø 5 m, MayTex-Acryl, with valance.

Frame finish:

RAL 9010 pure white

art. no. **SG5000 K001**

Frame finish:

RAL 9006 white aluminium

art. no. **SG5000 K002**

### Impact protection for parasol mast

Make sure that the children's playing area is safe. Without safety precautions, carefree romping around may lead to tears. The soft material protects from painful bumps up to a height of 90 cm. If correctly mounted, our protective padding also covers the anchor tube. The vertical connection is fully fastened by hook-and-loop fastener. Therefore, the impact protection is optimally adapted to the parasol mast and so helps to minimize hard edges and corners that may lead to abrasions. Made from MayTex-PVC, available in all PVC colours of our cloth collection.

art. no. **350268**



SCHATTELLO 4.0 x 6.0 m  
MayTex-Acryl SA 314 010 white

### Lubricant LubriMay 13

for threaded spindle, content: 100 g.

art. no. **350652**



### CleanoMay 13

This highly efficient cleaning concentrate removes grease, oil, coal, rust as well as other stubborn stains on your parasol canopy covering or frame. It can also serve to clean machines, kitchens (recognised as safe for foodstuffs by the Fresenius Institute), barbeque grills, tarpaulins and plastics. Moreover, CleanoMay 13 is non-toxic, biodegradable, non-flammable and non-corroding. 1 litre concentrate yields 26 litres liquid cleanser.

art. no. **350848**



### Substitute canopy covering

An occasional change of canopy covering can give your patio a completely new flair.







## TUBULAR MOTOR

You will find our product video at:  
[may.ag/e\\_en](http://may.ag/e_en)



### Tubular motor

fully integrated in parasol mast, invisible; start-up via Plug and Play, open and close by pressing function key of radio transmitter for 3 seconds (for avoidance of unintentional switching), range of radio transmitter to parasol mast approx. 25 m; Control exclusively via radio. No wired control (fixed wiring) possible. The motors can only be used with anchor tubes SZ150, SZ131, SZ127, SZ186, SZ194, SZ210, SZ241 or SZ243. Compatible with LED-lighting, not compatible with heaters or loudspeakers; Power: 230 V~/50 Hz.

art. no. **202100**



### Single-channel hand-held radio transmitter

single-channel device sufficient if only one parasol is to be controlled. Simultaneous control of one or any number of parasols possible (2 signals).

art. no. **202105**



### Holder for radio transmitter

suitable for single-channel hand-held radio transmitter 202105. To be screwed to the wall.

art. no. **202115**



### 18-channel hand-held radio transmitter

for the control of several parasols; can be used to control solitary as well as grouped parasols, programming possible in our company after prior date arrangement. 18-channel device. For separate control of up to 18 parasols (36 signals).

art. no. **202106**

SCHATTELLO 5.0 x 5.0 m  
 MayTex-Acryl SA 314 010 white

### Holder for radio transmitter

suitable for 18-channel hand-held radio transmitter 202106. To be screwed to the wall.

art. no. **202116**



**202106 + 202116**

### Wall-mounted radio transmitter

radio transmitter for permanent screw-on installation. The transmitter must have direct visual contact with the radio receiver. Sufficient for the control of one parasol. Simultaneous control of one or any number of parasols possible (2 signals).

art. no. **202104**



### Radio transmitting station

2-channel radio transmitter to open and close tubular motors by a home automation system (e.g. elero, elsner, GIRA, KNX, LOXONE, Rademacher or somfy). Direct visual contact to the radio transmitter required. Controls 1 or 2 parasols or 1 up to 2 groups of parasols. 4 signals; unidirectional and sequential. Simple integration by potential-free switching contacts (> 3 sec). Can be combined with an 18-channel radio transmitter for single or group control. Input 12 V - 24 V DC or 230 V~/ 50 Hz.

art. no. **202108**



### Wind sensor

only to be used as a supportive measure. In case of rising wind, the operator of the business must see that the parasols are closed and secured with a strap. The wind sensor measures the speed of the wind and passes on a signal to the tubular motor, which then automatically closes the parasols. The wind threshold value can be programmed with an adjustable potentiometer. Solar-cell and radio transmission, no cabling needed. To be fastened in a suitable position with the two dowels supplied in the package. The location should be as exposed as possible and in the vicinity of the parasols. Direct visual contact with the radio receiver necessary.

art. no. **202110**







SCHATTELLO 4.5 x 4.5 m  
MayTex-Acryl DA 8203 grey basalt



Below you will find a list of our range of all-in kits on offer.

Choose a parasol and one of the kits listed. From page 178 onwards you will find more information on the individual kit components. The kits can, however, only be applied in combination with installation option SZ127, SZ131, SZ150, SZ186, SZ194, SZ210, SZ241, SZ243, SZ273 or SZ275. We recommend 2 lights and 2 heaters for parasols with an area of up to 16 m<sup>2</sup>. For larger-size parasols 4 lights and 4 heaters will be necessary. It is not possible to combine heaters and a motor.

### Slim lights warm white



<b>Kit S 2</b> art. no. 350940		
230 V connection. Kit consists of:	quantity	art. no.
W-MAY 3-pole plug connector	1	352422
Power supply within centre pole	1	354522
Electrical harness	1	350933
<b>Slim light warm white 13 W</b>	<b>2</b>	<b>202090</b>

Cannot be used for parasol size 2 x 3 m.

<b>Kit S 4</b> art. no. 350941		
230 V connection. Kit consists of:	quantity	art. no.
W-MAY 3-pole plug connector	1	352422
Power supply within centre pole	1	354522
Electrical harness	1	350933
<b>Slim light warm white 13 W</b>	<b>4</b>	<b>202090</b>

Cannot be used for parasol size 2 x 3 m.

<b>Kit S 6</b> art. no. 350942		
230 V connection. Kit consists of:	quantity	art. no.
W-MAY 3-pole plug connector	1	352422
Power supply within centre pole	1	354522
Electrical harness	1	350933
<b>Slim light warm white 13 W</b>	<b>6</b>	<b>202090</b>

Cannot be used for parasol size 2 x 3 m.

<b>Kit S 2LED</b> art. no. 350943		
230 V connection. Kit consists of:	quantity	art. no.
W-MAY 3-pole plug connector	1	352422
Power supply within centre pole	1	354522
Electrical harness	1	350933
Power supply unit (PSU) for max. 6 LED bars, integrated in parasol	1	351920
<b>LED bar, warm white, without spot optics</b>	<b>2</b>	<b>352187</b>

<b>Kit S 4LED</b> art. no. 350944		
230 V connection. Kit consists of:	quantity	art. no.
W-MAY 3-pole plug connector	1	352422
Power supply within centre pole	1	354522
Electrical harness	1	350933
Power supply unit (PSU) for max. 6 LED bars, integrated in parasol	1	351920
<b>LED bar, warm white, without spot optics</b>	<b>4</b>	<b>352187</b>

<b>Kit S 6LED</b> art. no. 350988		
230 V connection. Kit consists of:	quantity	art. no.
W-MAY 3-pole plug connector	1	352422
Power supply within centre pole	1	354522
Electrical harness	1	350933
Power supply unit (PSU) for max. 6 LED bars, integrated in parasol	1	351920
<b>LED bar, warm white, without spot optics</b>	<b>6</b>	<b>352187</b>

### LED lighting RGB-ww (colours & warmwhite)

LED-bar RGB-ww (colours and warmwhite):  
Information on colour control  
and dimming by smartphone  
or Bluetooth remote control sender  
art. no. 352890, see page 186.



<b>Kit S 2RGB</b> art. no. 352960		
230 V connection. Kit consists of:	quantity	art. no.
W-MAY 3-pole plug connector	1	352422
Power supply within centre pole	1	354522
Electrical harness	1	350933
Power supply unit (PSU) for max. 6 LED bars, integrated in parasol	1	351920
Bluetooth remote dimmer v16-9	1	352888
<b>LED-bar RGB-ww (colours and warmwhite)</b>	<b>2</b>	<b>353925</b>

<b>Kit S 4RGB</b> art. no. 352961		
230 V connection. Kit consists of:	quantity	art. no.
W-MAY 3-pole plug connector	1	352422
Power supply within centre pole	1	354522
Electrical harness	1	350933
Power supply unit (PSU) for max. 6 LED bars, integrated in parasol	1	351920
Bluetooth remote dimmer v16-9	1	352888
<b>LED-bar RGB-ww (colours and warmwhite)</b>	<b>4</b>	<b>353925</b>

<b>Kit S 6RGB</b> art. no. 352962		
230 V connection. Kit consists of:	quantity	art. no.
W-MAY 3-pole plug connector	1	352422
Power supply within centre pole	1	354522
Electrical harness	1	350933
Power supply unit (PSU) for max. 6 LED bars, integrated in parasol	1	351920
Bluetooth remote dimmer v16-9	1	352888
<b>LED-bar RGB-ww (colours and warmwhite)</b>	<b>6</b>	<b>353925</b>

### LED lighting warm white

To dim the LED bar warm white by smart  
phone or radio transmitter order the  
Bluetooth remote dimmer art. no. 352888  
and the Bluetooth remote control  
sender art. no. 352890  
see page 186, if applicable.



### Infrared heaters

In standard cases these kits are firmly connected with the underground cable.  
Alternatively, plug connector art. no. 200581 can be used.



#### Kit S 0 2A art. no. 351490

400 V connection. Kit consists of:	quantity	art. no.
Power supply within centre pole	1	354526
Electrical harness	1	200565
Automatic auxiliary cut out switch	1	202051
Cabling, long (only possible along diagonal spokes)	2	200579
Swivelling holder	2	202040
<b>Infrared heater (RAL 9010 or 9006)</b>	<b>2</b>	<b>200430</b>

For parasol sizes 6 x 6 x 6 m with valance, Ø 3 m, Ø 3.5 m, Ø 4 m, Ø 4.5 m, Ø 5 m, Ø 5.5 m, 2 x 2 m, 2.5 x 2.5 m, 3.5 x 3.5 m, 2 x 3 m, 2 x 4 m, 2.5 x 3.0 m, 2.5 x 3.5 m and 4 x 4 x 4 m please opt for Kit S0 2Z.

#### Kit S 0 4A art. no. 351491

400 V connection. Kit consists of:	quantity	art. no.
Power supply within centre pole	1	354526
Electrical harness	1	200565
Automatic auxiliary cut out switch	1	202051
Cabling, long (only possible along diagonal spokes)	4	200579
Swivelling holder	4	202040
<b>Infrared heater (RAL 9010 or 9006)</b>	<b>4</b>	<b>200430</b>

For parasol sizes 6 x 6 x 6 m with valance, Ø 3 m, Ø 3.5 m, Ø 4 m, Ø 4.5 m, Ø 5 m, Ø 5.5 m, 3.5 x 3.5 m, 2 x 3 m, 2 x 4 m, 2.5 x 3.0 m, 2.5 x 3.5 m und 4 x 4 x 4 m please opt for Kit S0 4Z.

For parasol size 3 x 3 m eccentric opt for Kit S0 2A.

For sizes 2 x 2 m and 2.5 x 2.5 m opt for Kit S0 2Z.

#### Kit S 0 2Z art. no. 351492

400 V connection. Kit consists of:	quantity	art. no.
Power supply within centre pole	1	354526
Electrical harness	1	200565
Automatic auxiliary cut out switch	1	202051
Cabling, short (please state position intended)	2	200585
Swift-fold spar	2	200578
<b>Infrared heater (RAL 9010 or 9006)</b>	<b>2</b>	<b>200430</b>

For parasol sizes 3 x 3 m eccentric, 2 x 4 m eccentric and 3 x 4 m eccentric please opt for Kit S0 2A.

#### Kit S 0 4Z art. no. 351493

400 V connection. Kit consists of:	quantity	art. no.
Power supply within centre pole	1	354526
Electrical harness	1	200565
Automatic auxiliary cut out switch	1	202051
Cabling, short (please state position intended)	4	200585
Swift-fold spar	4	200578
<b>Infrared heater (RAL 9010 or 9006)</b>	<b>4</b>	<b>200430</b>

This kit cannot be used for parasol sizes 3 x 3 m eccentric, 2 x 4 m eccentric, 3 x 4 m eccentric, 2 x 2 m, 2.5 x 2.5 m, 3 x 3 m and 4 x 5 m.

We will be pleased to give advice on alternatives.

### Infrared heaters + slim lights warm white

In standard cases these kits are firmly connected with the underground cable.  
Alternatively, plug connector art. no. 200581 can be used.



#### Kit S 4 2A art. no. 202062

400 V connection. Kit consists of:	quantity	art. no.
Power supply within centre pole	1	354526
Electrical harness	1	200565
Automatic auxiliary cut out switch	1	202051
Cabling, long (only possible along diagonal spokes)	2	200579
Swivelling holder	2	202040
<b>Infrared heater (RAL 9010 or 9006)</b>	<b>2</b>	<b>200430</b>
<b>Slim light warm white 13 W</b>	<b>4</b>	<b>202090</b>

For parasol sizes 6 x 6 x 6 m with valance, Ø 3 m, Ø 4 m, Ø 5 m, 2 x 2 m, 2.5 x 2.5 m, 3.5 x 3.5 m, 2 x 3 m, 2 x 4 m, 2.5 x 3.0 m, 2.5 x 3.5 m and 4 x 4 x 4 m please opt for Kit S4 2Z.

#### Kit S 4 4A art. no. 202064

400 V connection. Kit consists of:	quantity	art. no.
Power supply within centre pole	1	354526
Electrical harness	1	200565
Automatic auxiliary cut out switch	1	202051
Cabling, long (only possible along diagonal spokes)	4	200579
Swivelling holder	4	202040
<b>Infrared heater (RAL 9010 or 9006)</b>	<b>4</b>	<b>200430</b>
<b>Slim light warm white 13 W</b>	<b>4</b>	<b>202090</b>

For parasol sizes 6 x 6 x 6 m with valance, Ø 3 m, Ø 4 m, Ø 5 m, 3.5 x 3.5 m, 2 x 3 m, 2 x 4 m, 2.5 x 3.0 m, 2.5 x 3.5 m and 4 x 4 x 4 m please opt for Kit S4 4Z.

For parasol size 3 x 3 m eccentric opt for Kit S4 2A.

For sizes 2 x 2 m and 2.5 x 2.5 m please opt for Kit S4 2Z.

#### Kit S 4 2Z art. no. 207062

400 V connection. Kit consists of:	quantity	art. no.
Power supply within centre pole	1	354526
Electrical harness	1	200565
Automatic auxiliary cut out switch	1	202051
Cabling, short (please state position intended)	2	200585
Swift-fold spar	2	200578
<b>Infrared heater (RAL 9010 or 9006)</b>	<b>2</b>	<b>200430</b>
<b>Slim light warm white 13 W</b>	<b>4</b>	<b>202090</b>

For parasol sizes 3 x 3 m eccentric, 2 x 4 m eccentric and 3 x 4 m eccentric please opt for Kit S4 2A.

Cannot be used for parasol size 2 x 3 m.

#### Kit S 4 4Z art. no. 207064

400 V connection. Kit consists of:	quantity	art. no.
Power supply within centre pole	1	354526
Electrical harness	1	200565
Automatic auxiliary cut out switch	1	202051
Cabling, short (please state position intended)	4	200585
Swift-fold spar	4	200578
<b>Infrared heater (RAL 9010 or 9006)</b>	<b>4</b>	<b>200430</b>
<b>Slim light warm white 13 W</b>	<b>4</b>	<b>202090</b>

This kit cannot be used for parasol sizes 3 x 3 m eccentric, 2 x 4 m eccentric, 3 x 4 m eccentric, 2 x 2 m, 2.5 x 2.5 m, 3 x 3 m and 4 x 5 m. We will be pleased to give advice on alternatives.

Cannot be used for parasol size 2 x 3 m.



### Infrared heaters + LED lighting warm white

In standard cases these kits are firmly connected with the underground cable.

Alternatively, plug connector art. no. 200581 can be used.

To dim the LED bar warm white by smart phone or radio transmitter, order the Bluetooth remote dimmer art. no. 352888 and the Bluetooth remote control sender art. no. 352890 see page 186, if applicable.

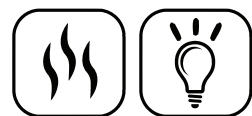

#### Kit S 4LED 2A art. no. 350953

400 V connection. Kit consists of:	quantity	art. no.
Power supply within centre pole	1	354526
Electrical harness	1	200565
Automatic auxiliary cut out switch	1	202051
Cabling, long (only possible along diagonal spokes)	2	200579
Swivelling holder	2	202040
<b>Infrared heater (RAL 9010 or 9006)</b>	<b>2</b>	<b>200430</b>
Power supply unit (PSU) for max. 6 LED bars, integrated in parasol	1	351920
<b>LED bar, warm white, without spot optics</b>	<b>4</b>	<b>352187</b>

For parasol sizes 6 x 6 x 6 m with valance, Ø 3 m, Ø 4 m, Ø 5 m, 2 x 2 m, 2.5 x 2.5 m, 3.5 x 3.5 m, 2 x 3 m, 2 x 4 m, 2.5 x 3.0 m, 2.5 x 3.5 m and 4 x 4 x 4 m please opt for Kit S 4LED 2Z.

#### Kit S 4LED 4A art. no. 350954

400 V connection. Kit consists of:	quantity	art. no.
Power supply within centre pole	1	354526
Electrical harness	1	200565
Automatic auxiliary cut out switch	1	202051
Cabling, long (only possible along diagonal spokes)	4	200579
Swivelling holder	4	202040
<b>Infrared heater (RAL 9010 or 9006)</b>	<b>4</b>	<b>200430</b>
Power supply unit (PSU) for max. 6 LED bars, integrated in parasol	1	351920
<b>LED bar, warm white, without spot optics</b>	<b>4</b>	<b>352187</b>

For parasol sizes 6 x 6 x 6 m with valance, Ø 3 m, Ø 4 m, Ø 5 m, 3.5 x 3.5 m, 2 x 3 m, 2 x 4 m, 2.5 x 3.0 m, 2.5 x 3.5 m and 4 x 4 x 4 please opt for Kit S4 LED 4Z.

For size 3 x 3 m eccentric opt for Kit S4 LED 2A.

For sizes 2 x 2 m and 2.5 x 2.5 m opt for Kit S4 LED 2Z.

Cannot be used for parasol size 2 x 3 m.

#### Kit S 4LED 2Z art. no. 350955

400 V connection. Kit consists of:	quantity	art. no.
Power supply within centre pole	1	354526
Electrical harness	1	200565
Automatic auxiliary cut out switch	1	202051
Cabling, short (please state position intended)	2	200585
Swift-fold spar	2	200578
<b>Infrared heater (RAL 9010 or 9006)</b>	<b>2</b>	<b>200430</b>
Power supply unit (PSU) for max. 6 LED bars, integrated in parasol	1	351920
<b>LED bar, warm white, without spot optics</b>	<b>4</b>	<b>352187</b>

For parasol sizes 3 x 3 m eccentric, 2 x 4 m eccentric and 3 x 4 m eccentric please opt for Kit S 4LED 2A.

### Infrared heaters + LED lighting RGB-ww (colours & warmwhite)

In standard cases these kits are firmly connected with the underground cable.

Alternatively, plug connector art. no. 200581 can be used.

LED-bar RGB-ww (colours and warmwhite):  
Information on colour control and dimming by smartphone or Bluetooth remote control sender art. no. 352890, see page 186.

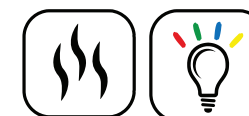

#### Kit S 4LED 4Z art. no. 350956

400 V connection. Kit consists of:	quantity	art. no.
Power supply within centre pole	1	354526
Electrical harness	1	200565
Automatic auxiliary cut out switch	1	202051
Cabling, short (please state position intended)	4	200585
Swift-fold spar	4	200578
<b>Infrared heater (RAL 9010 or 9006)</b>	<b>4</b>	<b>200430</b>
Power supply unit (PSU) for max. 6 LED bars, integrated in parasol	1	351920
<b>LED bar, warm white, without spot optics</b>	<b>4</b>	<b>352187</b>

This kit cannot be used for parasol sizes 3 x 3 m eccentric, 2 x 4 m eccentric, 3 x 4 m eccentric, 2 x 2 m, 2.5 x 2.5 m, 3 x 3 m and 4 x 5 m.

We will be pleased to give advice on alternatives.

#### Kit S 4RGB 2A art. no. 352970

400 V connection. Kit consists of:	quantity	art. no.
Power supply within centre pole	1	200369
Electrical harness	1	200565
Automatic auxiliary cut out switch	1	202051
Cabling, long (only possible along diagonal spokes)	2	200579
Swivelling holder	2	202040
<b>Infrared heater (RAL 9010 or 9006)</b>	<b>2</b>	<b>200408</b>
Power supply unit (PSU) for max. 6 LED bars, integrated in parasol	1	351920
Bluetooth remote dimmer v16-9	1	352888
<b>LED-bar RGB-ww (colours and warmwhite)</b>	<b>4</b>	<b>353925</b>

For parasol sizes 6 x 6 x 6 m with valance, Ø 3 m, Ø 4 m, Ø 5 m, 2 x 2 m, 2.5 x 2.5 m, 3.5 x 3.5 m, 2 x 3 m, 2 x 4 m, 2.5 x 3.0 m, 2.5 x 3.5 m and 4 x 4 x 4 please opt for Kit S4 LED 2Z.

#### Kit S 4RGB 4A art. no. 352971

400 V connection. Kit consists of:	quantity	art. no.
Power supply within centre pole	1	354526
Electrical harness	1	200565
Automatic auxiliary cut out switch	1	202051
Cabling, long (only possible along diagonal spokes)	4	200579
Swivelling holder	4	202040
<b>Infrared heater (RAL 9010 or 9006)</b>	<b>4</b>	<b>200430</b>
Power supply unit (PSU) for max. 6 LED bars, integrated in parasol	1	351920
Bluetooth remote dimmer v16-9	1	352888
<b>LED-bar RGB-ww (colours and warmwhite)</b>	<b>4</b>	<b>353925</b>

For parasol sizes 6 x 6 x 6 m with valance, Ø 3 m, Ø 4 m, Ø 5 m, 3.5 x 3.5 m, 2 x 3 m, 2 x 4 m, 2.5 x 3.0 m, 2.5 x 3.5 m and 4 x 4 x 4 please opt for Kit S4 RGB 4Z.

For size 3 x 3 m eccentric opt for Kit S4 RGB 2A.

For sizes 2 x 2 m and 2.5 x 2.5 m opt for Kit S4 RGB 2Z.

### Kit S 4RGB 2Z art. no. 352972

400 V connection. Kit consists of:	quantity	art. no.
Power supply within centre pole	1	354526
Electrical harness	1	200565
Automatic auxiliary cut out switch	1	202051
Cabling, short (please state position intended)	2	200585
Swift-fold spar	2	200578
<b>Infrared heater (RAL 9010 or 9006)</b>	<b>2</b>	<b>200430</b>
Power supply unit (PSU) for max. 6 LED bars, integrated in parasol	1	351920
Bluetooth remote dimmer v16-9	1	352888
<b>LED-bar RGB-ww (colours and warmwhite)</b>	<b>4</b>	<b>353925</b>

For parasol sizes 3 x 3 m eccentric, 2 x 4 m eccentric and 3 x 4 m eccentric please opt for Kit S 4RGB 2A.

### Kit S 4RGB 4Z art. no. 352973

400 V connection. Kit consists of:	quantity	art. no.
Power supply within centre pole	1	354526
Electrical harness	1	200565
Automatic auxiliary cut out switch	1	202051
Cabling, short (please state position intended)	4	200585
Swift-fold spar	4	200578
<b>Infrared heater (RAL 9010 or 9006)</b>	<b>4</b>	<b>200430</b>
Power supply unit (PSU) for max. 6 LED bars, integrated in parasol	1	351920
Bluetooth remote dimmer v16-9	1	352888
<b>LED-bar RGB-ww (colours and warmwhite)</b>	<b>4</b>	<b>353925</b>

This kit cannot be used for parasol sizes 3 x 3 m eccentric, 2 x 4 m eccentric, 3 x 4 m eccentric, 2 x 2 m, 2.5 x 2.5 m, 3 x 3 m and 4 x 5 m. We will be pleased to give advice on alternatives.

### Kit S 0 M art. no. 353014

230 V connection. Kit consists of	quantity	art. no.
W-MAY 3-pole plug connector	1	352422
<b>Tubular motor (radio controlled)</b>	<b>1</b>	<b>202100</b>
Electrical harness	1	350933

## Tubular motor + LED lighting warm white

Tubular motor: Please order radio transmitter separately, see page 92.

To dim the LED bar warm white by smart phone or radio transmitter, order the Bluetooth remote dimmer art. no. 352888 and the Bluetooth remote control sender art. no. 352890 see page 186, if applicable.

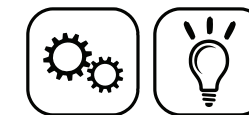

### Kit S 2LED M art. no. 350946

12 V + 230 V connection. Kit consists of:	quantity	art. no.
W-MAY 3-pole plug connector	1	352422
H1-MAY plug connector	1	350931
Power supply within centre pole	1	354523
Electrical harness	1	350933
Power supply unit (PSU) for max. 6 LED bars, installed on the outdoor wall or inside the house	1	351920
<b>LED bar, warm white, without spot optics</b>	<b>2</b>	<b>352187</b>
<b>Tubular motor (radio controlled)</b>	<b>1</b>	<b>202100</b>

### Kit S 4LED M art. no. 350947

12 V + 230 V connection. Kit consists of:	quantity	art. no.
W-MAY 3-pole plug connector	1	352422
H1-MAY plug connector	1	350931
Power supply within centre pole	1	354523
Electrical harness	1	350933
Power supply unit (PSU) for max. 6 LED bars, installed on the outdoor wall or inside the house	1	351920
<b>LED bar, warm white, without spot optics</b>	<b>4</b>	<b>352187</b>
<b>Tubular motor (radio controlled)</b>	<b>1</b>	<b>202100</b>

### Kit S 6LED M art. no. 350948

12 V + 230 V connection. Kit consists of:	quantity	art. no.
W-MAY 3-pole plug connector	1	352422
H1-MAY plug connector	1	350931
Power supply within centre pole	1	354523
Electrical harness	1	350933
Power supply unit (PSU) for max. 6 LED bars, installed on the outdoor wall or inside the house	1	351920
<b>LED bar, warm white, without spot optics</b>	<b>6</b>	<b>352187</b>
<b>Tubular motor (radio controlled)</b>	<b>1</b>	<b>202100</b>

## Tubular motor

Please order radio transmitter separately, see page 92.





## Tubular motor + LED lighting RGB-ww (colours & warmwhite)

Tubular motor: Please order radio transmitter separately, see page 92.

LED-bar RGB-ww (colours and warmwhite): Information on colour control and dimming by smartphone or Bluetooth remote control sender art. no. 352890, see page 186.

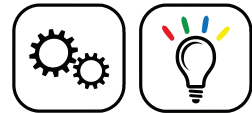

**Kit S 2RGB M** art. no. 352963

12 V + 230 V connection. Kit consists of:

	quantity	art. no.
W-MAY 3-pole plug connector	1	352422
H1-MAY plug connector	1	350931
Power supply within centre pole	1	354523
Electrical harness	1	350933
Power supply unit (PSU) for max. 6 LED bars, installed on the outdoor wall or inside the house	1	351920
Bluetooth remote dimmer v16-9	1	352888
<b>LED-bar RGB-ww (colours and warmwhite)</b>	<b>2</b>	<b>353925</b>
<b>Tubular motor (radio controlled)</b>	<b>1</b>	<b>202100</b>

**Kit S 4RGB M** art. no. 352964

12 V + 230 V connection. Kit consists of:

	quantity	art. no.
W-MAY 3-pole plug connector	1	352422
H1-MAY plug connector	1	350931
Power supply within centre pole	1	354523
Electrical harness	1	350933
Power supply unit (PSU) for max. 6 LED bars, installed on the outdoor wall or inside the house	1	351920
Bluetooth remote dimmer v16-9	1	352888
<b>LED-bar RGB-ww (colours and warmwhite)</b>	<b>4</b>	<b>353925</b>
<b>Tubular motor (radio controlled)</b>	<b>1</b>	<b>202100</b>

**Kit S 6RGB M** art. no. 352965

12 V + 230 V connection. Kit consists of:

	quantity	art. no.
W-MAY 3-pole plug connector	1	352422
H1-MAY plug connector	1	350931
Power supply within centre pole	1	354523
Electrical harness	1	350933
Power supply unit (PSU) for max. 6 LED bars, installed on the outdoor wall or inside the house	1	351920
Bluetooth remote dimmer v16-9	1	352888
<b>LED-bar RGB-ww (colours and warmwhite)</b>	<b>6</b>	<b>353925</b>
<b>Tubular motor (radio controlled)</b>	<b>1</b>	<b>202100</b>



SCHATTELLO Ø 5.0 m  
MayTex-Acryl SA 314 763 bordeaux  
alternating with SA 314 347 ruby



### SCHATTELLO – mobile installation options

#### Full frame pedestals for 1 set of concrete slabs

##### Full frame pedestal

frame size 103 x 111 cm, total height 29 cm, height of frame x = 5 cm, for 6- and 8-segment parasols, galvanized, weight approx. 30 kg. For 1 set of standard concrete slabs 50 x 50 x 5 cm.

art. no. **SZ411**

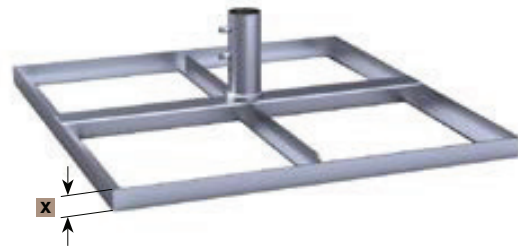

#### Full frame pedestal with 4 rubber diagonal support levelling screws

frame size 103 x 111 cm, total height min. 32 cm, max. 36 cm, for 6- and 8-segment parasols, galvanized, weight approx. 30 kg. For 1 set of standard concrete slabs 50 x 50 x 5 cm.

art. no. **SZ412**



#### Full frame pedestal on wheels

with rubber heavy-duty rollers and fixing brakes, frame size 103 x 111 cm, total height 36 cm, diameter of rollers 5 cm, for 6- and 8-segment parasols, galvanized, weight approx. 31 kg. For 1 set of standard concrete slabs 50 x 50 x 5 cm. Attention: wind sensitive!

art. no. **SZ414**



#### Heavy-duty wheels Ø 15 cm

wheel diameter 15 cm, for uneven surfaces. Rubber, with fixing brakes, loading capacity 110 kg/wheel. suitable for SZ414 and SZ205.

For orders with full frame pedestal

art. no. **351498**

For retrofitting

art. no. **351499**

#### Full frame pedestal on feet

for forklift or lift truck transport, frame size 103 x 111 cm, foot height y = 10 cm, for 6- and 8-segment parasols, galvanized, weight approx. 30 kg. For 1 set of standard concrete slabs 50 x 50 x 5 cm.

art. no. **SZ420**



### SCHATTELLO – mobile installation options

#### Frame pedestal cover plate

stainless steel 1.4310, fits for SZ411, SZ412, SZ414 and SZ420. For retrofitting.

art. no. **200906**



SZ412 with 200906

#### Full frame pedestals for 2 sets of concrete slabs

##### Full frame pedestal

frame size 103 x 103 cm, total height 34 cm, height of frame x = 5 cm, galvanized, weight approx. 28 kg. For 2 sets of standard concrete slabs 50 x 50 x 5 cm.

art. no. **SZ201**

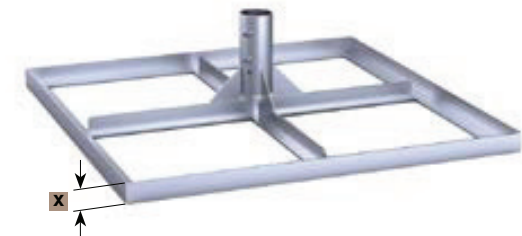

#### Full frame pedestal

with rubber diagonal support levelling screws, frame size 103 x 103 cm, total height min. 37 cm, max. 41 cm, galvanized, weight approx. 29 kg. For 2 sets of standard concrete slabs 50 x 50 x 5 cm.

art. no. **SZ203**



#### Full frame pedestal on wheels

with rubber heavy-duty rollers and fixing brakes, frame size 103 x 103 cm, total height 41 cm, diameter of rollers 5 cm, galvanized, weight approx. 29 kg. For 2 sets of standard concrete slabs 50 x 50 x 5 cm. Attention: wind sensitive!

art. no. **SZ205**





### SCHATTELLO – mobile installation options

#### Full frame pedestal

customized height to fit patio surface, frame size 103 x 103 cm, screw-off upper part, for 6- and 8-segment parasols, galvanized, weight approx. 29 kg, incl. top plate for winter protection. For 1 set of standard concrete slabs 50 x 50 x 5 cm, s = Ø 10 cm.

art. no. **SZ208**

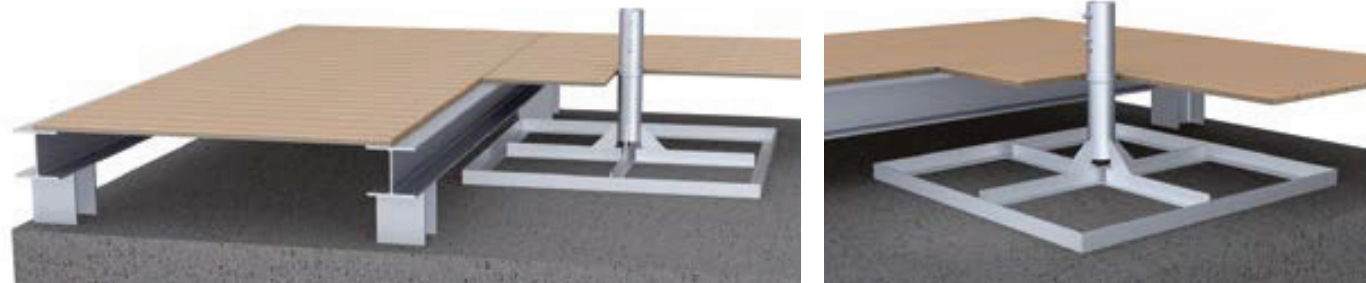
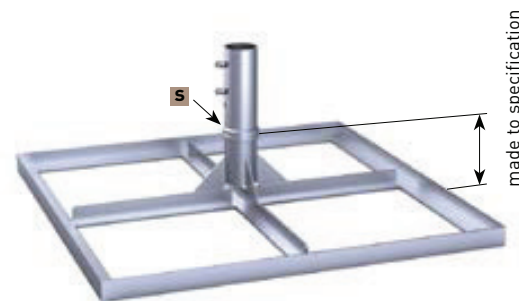

#### Full frame pedestal with placement hinge

customized height to fit patio surface, frame size 103 x 103 cm, screw-off upper part, galvanized, weight approx. 32 kg, incl. top plate for winter protection. For 1 set of standard concrete slabs 50 x 50 x 5 cm, v = bore for power cable through centre post Ø 7 cm, x = 16 cm, y = 17.5 cm.

art. no. **SZ210**

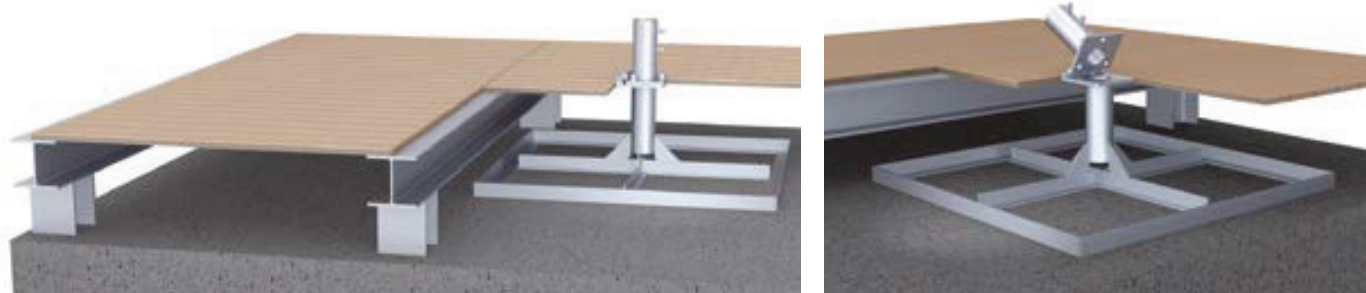
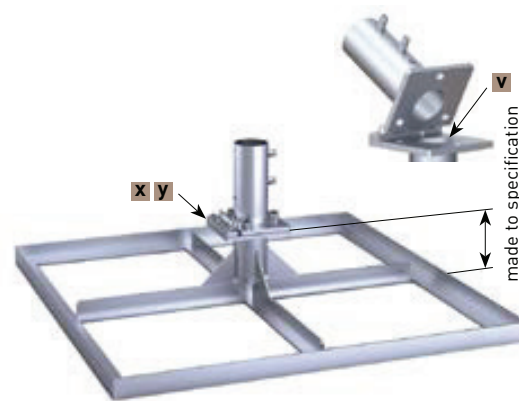

#### Concrete slabs

1 set = 4 slabs, each 50 x 50 x 5 cm, weight per slab: approx. 31 kg, total weight approx. 124 kg.

art. no. **XZ50**



### SCHATTELLO – mobile installation options

#### Steel plates with cut off edge

1 set = 4 slabs, each 50 x 50 x 1.2 cm. Cut off edge 70 mm x 45°. Weight per slab: approx. 29 kg, total weight approx. 116 kg.

art. no. **XZ51**



#### Free-standing base plate

for parasols up to 21 m<sup>2</sup> in size, to be screwed together on site, heaviest component approx. 50 kg, base plate size 147 x 147 cm, steel plate thickness x = 12 mm, galvanized, weight approx. 213 kg.

art. no. **SZ272**

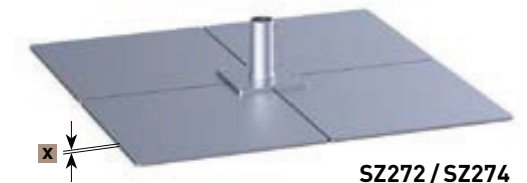

**SZ272 / SZ274**

#### Free-standing base plate

for parasols from 21 m<sup>2</sup> in size, to be screwed together on site, heaviest component approx. 63 kg, base plate size 147 x 147 cm, steel plate thickness x = 15 mm, galvanized, weight approx. 263 kg.

art. no. **SZ274**

#### Base plate with placement hinge

for parasols up to 21 m<sup>2</sup> in size, to be screwed together on site, heaviest component approx. 50 kg, base plate size 147 x 147 cm, v = bore for power cable through centre post Ø 7 cm, steel plate thickness x = 12 mm, galvanized, weight approx. 214 kg.

art. no. **SZ273**

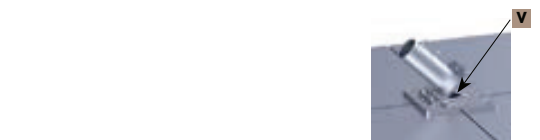

**SZ273 / SZ275**

#### Base plate with placement hinge

for parasols from 21 m<sup>2</sup> in size, to be screwed together on site, heaviest component approx. 63 kg, base plate size 147 x 147 cm, steel plate thickness x = 15 mm, galvanized, weight approx. 264 kg.

art. no. **SZ275**

#### Anti-slip mat

1 set = 4 pieces 73 x 73 cm each, suitable for the steel plates of the installation options SZ272, SZ273, SZ274, SZ275, SZ240, SZ241, SZ242 and SZ243. Increases the coefficient of friction between steel plate and floor covering (wood, concrete slabs, asphalt), and therefore reduces the risk of slipping during windy weather. Colour black, x = 3 mm.

art. no. **352789**



### SCHATTELLO – stationary installation options

#### Anchor tube to be embedded in concrete

2 pieces, screw-off upper part, for 6- and 8-segment parasols,  
galvanized, weight approx. 7 kg, incl. top plate for winter protection.  
a = 22 cm, b = 29 cm, s = Ø 10 cm, y = 16 cm.

art. no. **SZ118**

#### Anchor tube to be embedded in concrete

identical with SZ118, stainless steel (1.4571)

art. no. **352453**

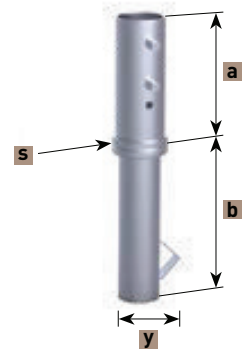

### SZ118 options: galvanized with additional powder-coating

#### Standard length



#### Extra length + 10 cm

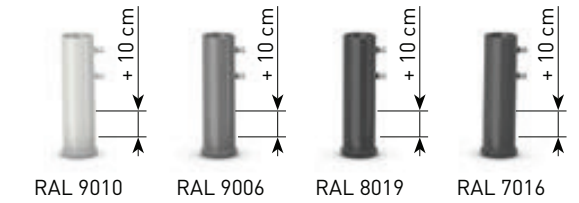

#### Extra length + 20 cm

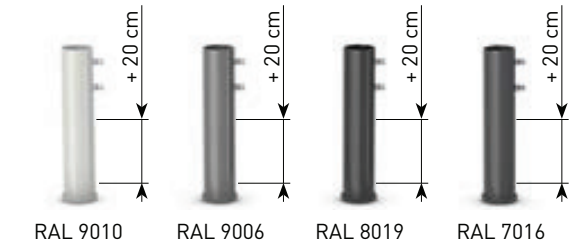

#### Extra length + 30 cm

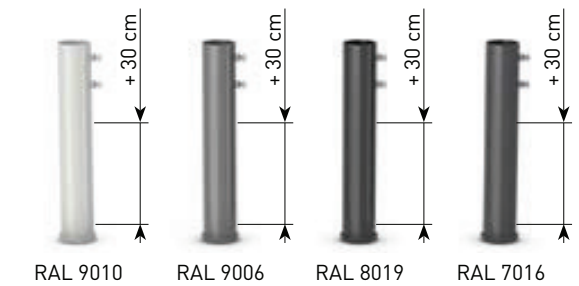

#### Extra length + 40 cm

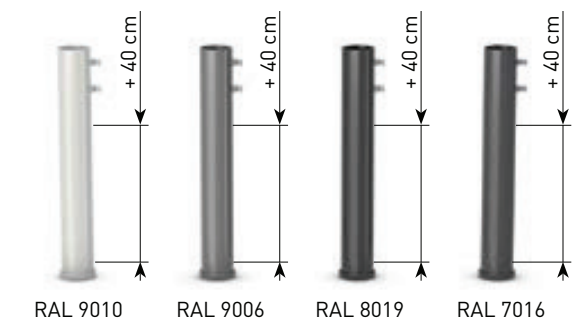

### SZ118 options: galvanized

#### SZ118 upper anchor tube, extra length

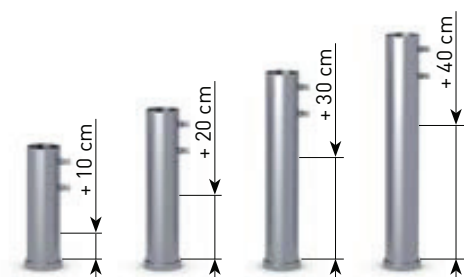

#### SZ118 lower anchor tube, extra length

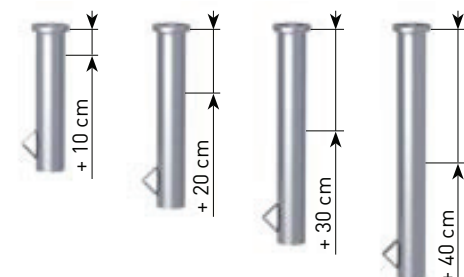



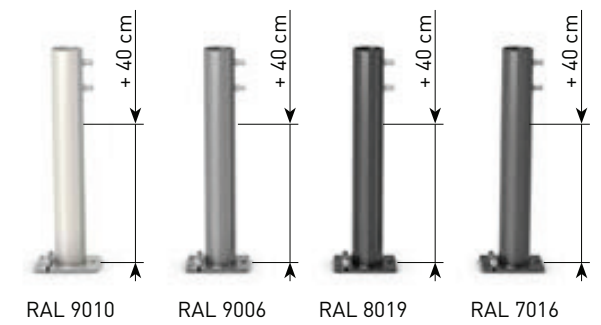
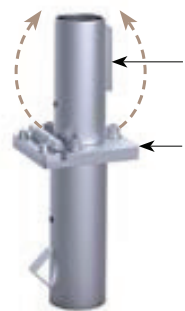
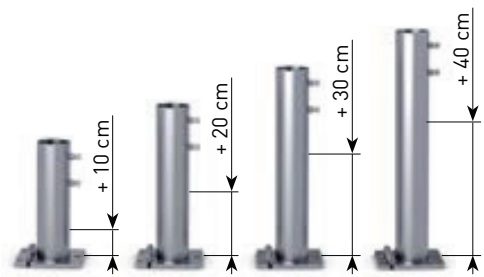
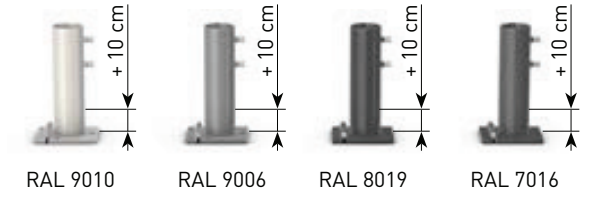
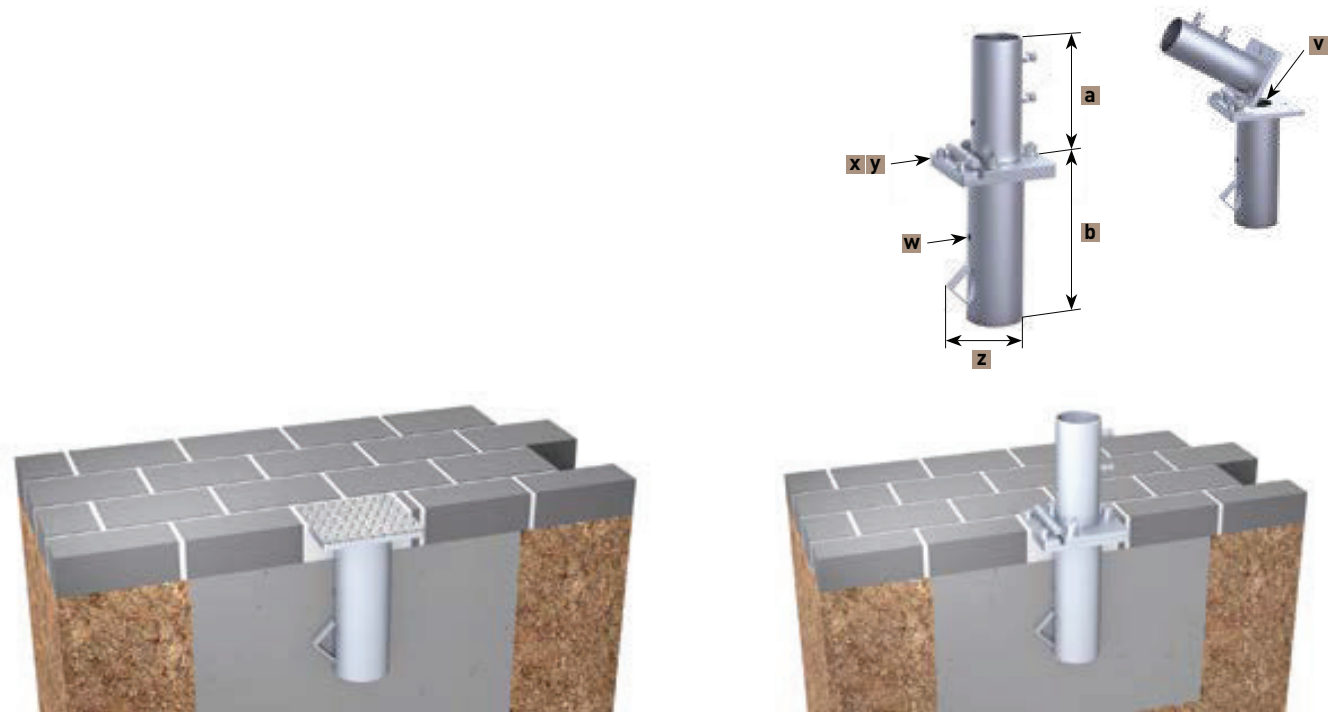

### SCHATTELLO – stationary installation options

#### Anchor tube to be embedded in concrete

for an existing foundation with a bore hole of min.  $\varnothing$  71 mm, 2 pieces, screw-off upper part, for 6- and 8-segment parasols. Bore hole filled with grouting or epoxy resin to fix lower part of anchor tube. Existing foundation must be adequate in size for the designated parasol. Galvanized, weight approx. 5 kg, lower tube square, incl. top plate for winter protection, a = 22 cm, b = 29 cm, s =  $\varnothing$  10 cm, y =  $\square$  5 cm.

art. no. **SZ146**

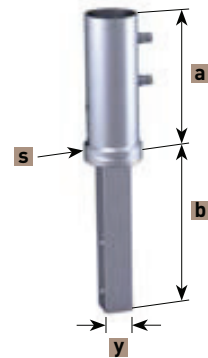

#### Dowel-anchored plate

2 pieces, screw-off upper part, for 6- and 8-segment parasols, galvanized, weight approx. 14 kg, a = 22 cm, x =  $\square$  30 cm, t = 1.5 cm, z =  $\varnothing$  1.8 cm

art. no. **SZ261**

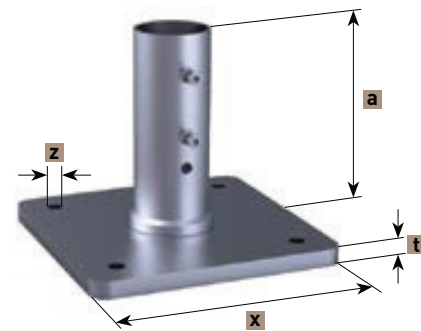

#### Dowel-anchored plate with placement hinge

galvanized, weight approx. 11.8 kg, v = bore for power cable through centre post  $\varnothing$  7 cm, a = 23 cm, x = 26 cm, y = 27.5 cm, t = 1.2 cm, z =  $\varnothing$  1.8 cm

art. no. **SZ131**

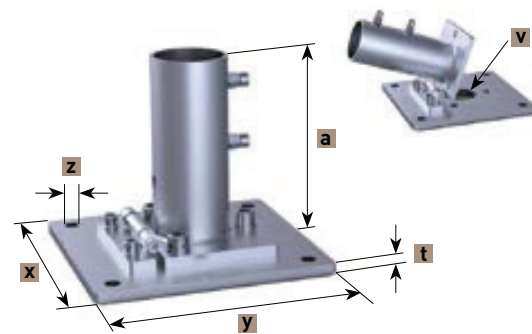

### SCHATTELLO – stationary installation options

#### Dowel-anchored plate

customized height to fit patio surface, anchor plate 50 x 50 cm, screw-off upper part, for 6- and 8-segment parasols, galvanized, weight approx. 32 kg, incl. top plate for winter protection, s =  $\varnothing$  10 cm.

art. no. **SZ129**

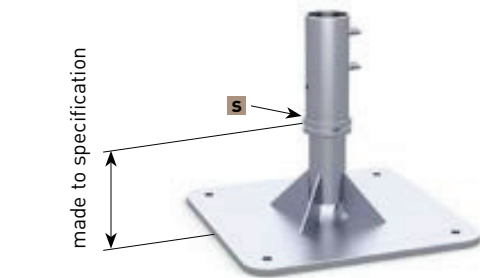
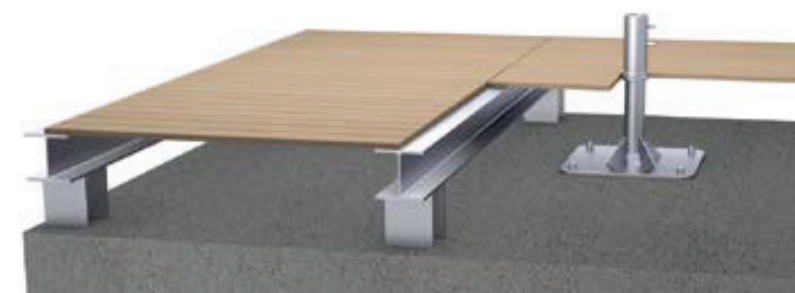

#### Dowel-anchored plate with placement hinge

customized height to fit patio surface, anchor plate 50 x 50 cm, screw-off upper part, galvanized, weight approx. 33 kg, incl. top plate for winter protection. v = bore for power cable through centre post  $\varnothing$  7 cm, x = 16 cm, y = 17.5 cm.

art. no. **SZ127**

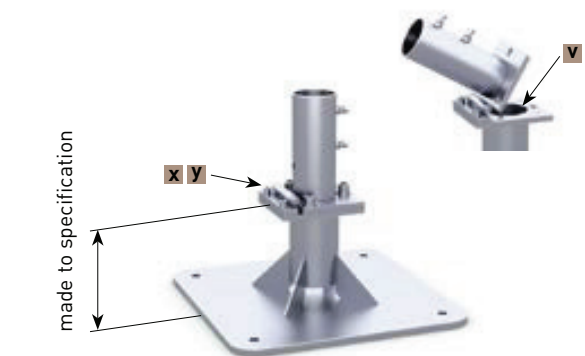
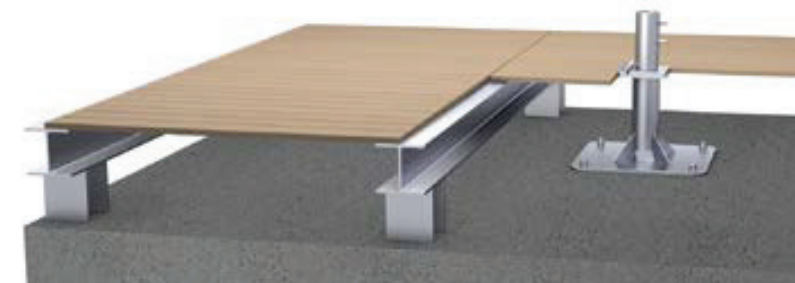



### SCHATTELLO – stationary installation options

#### Flat-roof dowel-anchored plate with placement hinge

externally insulated roof system, system-conform flat roof connection with liquid plastic, customized height to fit flat roof surface, dowel plate 50 x 50 cm, screw-off upper part, galvanized, weight approx. 38 kg, incl. top plate for winter protection. v = bore for power cable through centre post  $\varnothing$  7 cm, x = 16 cm, y = 17.5 cm.

art. no. **SZ186**

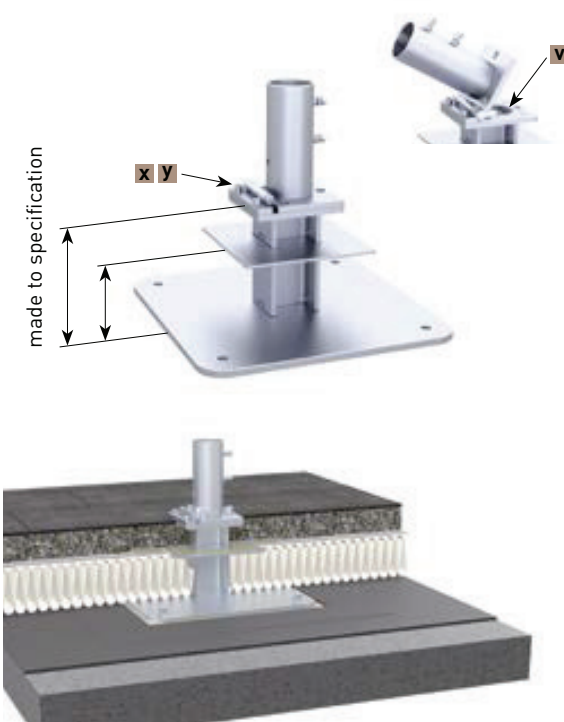
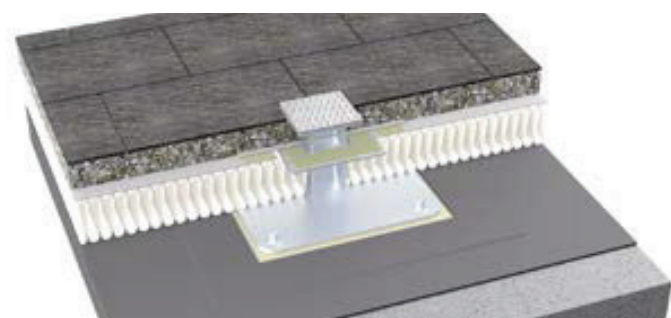

#### Flat-roof dowel-anchored plate with upper anchor tube

externally insulated roof system, loose-and-fixed flange assembly, bitumen waterproofing system and synthetic waterproofing material. Total height is determined by order to achieve the same level as the flat roof ground, dowelled plate 50 x 50 cm. Upper part removable, galvanized, weight approx. 37 kg, including top plate for winter protection.

v = bore for power cable through centre post  $\varnothing$  7 cm, x = 16 cm, y = 17.5 cm.

art. no. **SZ194**

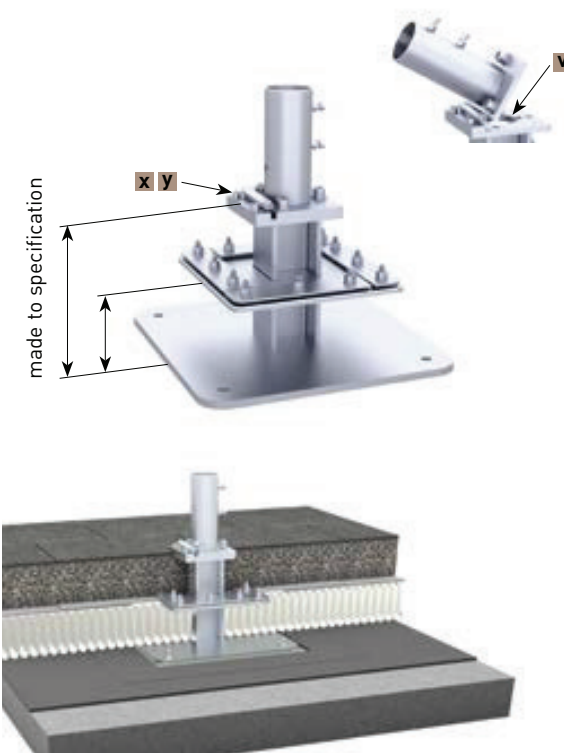
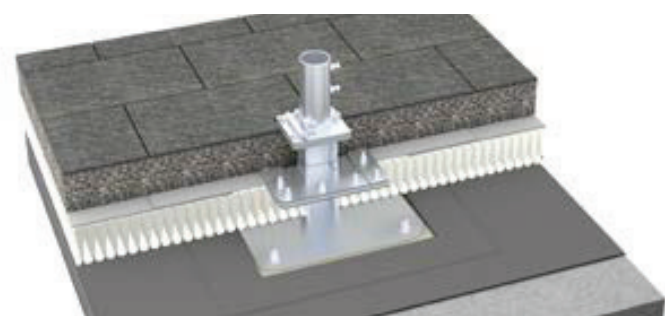

### SCHATTELLO – stationary installation options

#### Wall bracket

galvanized, weight approx. 5.5 kg, ground plate 30 x 20 cm, x = 7 cm, t = 1 cm. Bottom end of centre pole is supported by the bottom of the tube. The height is changed by the measure y = 5 cm. This option only makes sense in case of low balustrades and ledges, otherwise the parasol will hit the wall.

art. no. **RZ125**



#### Wall pressure plate

fits for RZ125, galvanized; 30 x 20 cm; to be clamped onto the existing bars (only possible if these are very strong), bore holes for M16 stud bolts (not included in the delivery).

art. no. **352579**



RZ125 in combination  
with 352579

#### Anchor bolt

bolt and nut, fits for SZ261, SZ131, SZ127, SZ129, SZ186 and SZ194; approved for cracked and non-cracked concrete B25 to B55 (old compressive strength classes) C20/25 to C50/60, (new EU classification), also suitable for concrete B15 and natural stone with dense structure. Concrete bore hole  $\varnothing$  16 x 115 mm. in stainless steel A4. Package contains 4 bolts. European Technical Approval ETA-05/0069.

art. no. **200900**



### SCHATTELLO – stationary installation options

#### Ground screw anchor fixture

Upper anchor tube, suitable for ground screw KSF F 140 x 2100-M, Screw-in ground anchor not included in delivery, standard parts for screwing included, for 6- and 8-segment parasols, Hot-dip galvanized, weight approx. 6 kg, a = 26 mm, x = 22 cm, t = 1.5 cm, see page 210 for further information.

art. no. **SZ329**



#### Screw-in ground anchor

ground screw with upper anchor tube, incl. standard parts, parts unscrewed on delivery, steel, for 6- and 8-segment parasols, galvanized acc. DIN EN ISO 1461, weight approx. 30 kg, delivered in two ready-to-assemble parts. See page 210 for further information.

art. no. **SZ330**

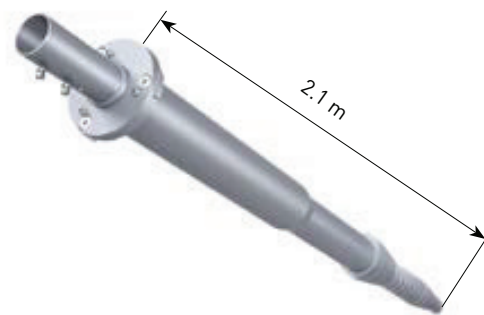

#### Ground screw anchor fixture with placement hinge

Upper anchor tube, suitable for ground screw KSF F 140 x 2100-M, Screw-in ground anchor not included in delivery, standard parts for screwing included, hot-dip galvanized, weight approx. 22 kg, v = bore for power cable through centre post Ø 7 cm, x = 32 cm, y = 29 cm, see page 210 for further information.

art. no. **SZ349**

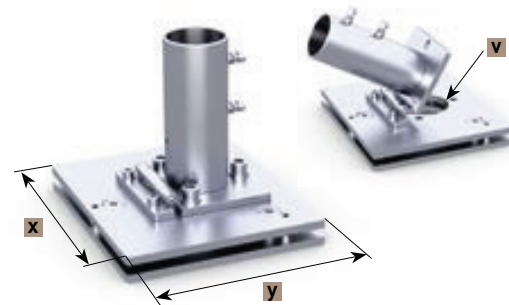

#### Ground screw anchor fixture with placement hinge

suitable for all sizes up to 28 m<sup>2</sup>; ground screw with upper anchor tube, incl. standard parts, parts unscrewed on delivery, steel, galvanized acc. DIN EN ISO 1461, weight approx. 46 kg, incl. top plate for winter protection. delivered in two ready-to-assemble parts. v = bore for power cable through centre post Ø 7 cm. For further information see page 210 onwards.

art. no. **SZ350**

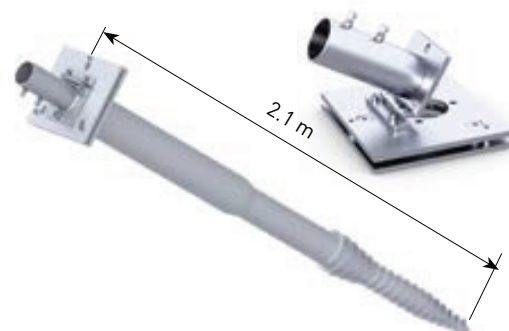

### SCHATTELLO – stationary installation options

#### Base plate

customized height to fit patio surface, for parasols up to 21 m<sup>2</sup> in size, to be screwed together on site, heaviest component approx. 50 kg, base plate size 147 x 147 cm, steel plate thickness x = 12 mm, screw-off upper part, for 6- and 8-segment parasols, galvanized, weight approx. 224 kg, incl. top plate for winter protection, y = □ 28 cm.

art. no. **SZ240**

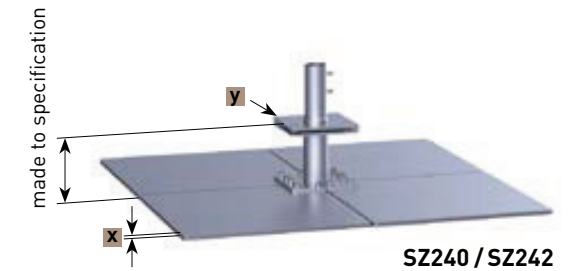

**SZ240 / SZ242**

#### Base plate

customized height to fit patio surface, for parasols from 21 m<sup>2</sup> in size, to be screwed together on site, heaviest component approx. 63 kg, base plate size 147 x 147 cm, steel plate thickness x = 15 mm, screw-off upper part, for 6- and 8-segment parasols, galvanized, weight approx. 274 kg, incl. top plate for winter protection, y = □ 28 cm.

art. no. **SZ242**

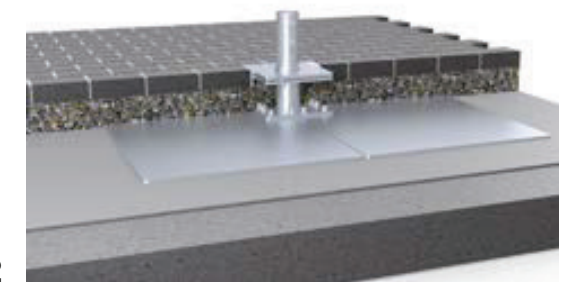

#### Base plate with placement hinge

customized height to fit patio surface, for parasols up to 21 m<sup>2</sup> in size, to be screwed together on site, heaviest component approx. 50 kg, base plate size 147 x 147 cm, steel plate thickness x = 12 mm, screw-off upper part, galvanized, weight approx. 225 kg, incl. top plate for winter protection. v = bore for power cable through centre post Ø 7 cm, y = □ 28 cm.

art. no. **SZ241**

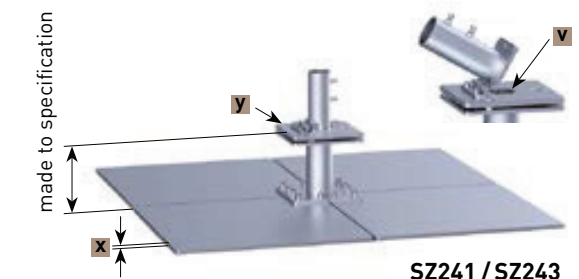

**SZ241 / SZ243**

#### Base plate with placement hinge

customized height to fit patio surface, for parasols up to from 21 m<sup>2</sup> in size, to be screwed together on site, heaviest component approx. 63 kg, base plate size 147 x 147 cm, steel plate thickness x = 15 mm, screw-off upper part, galvanized, weight approx. 275 kg, incl. top plate for winter protection, y = □ 28 cm.

art. no. **SZ243**

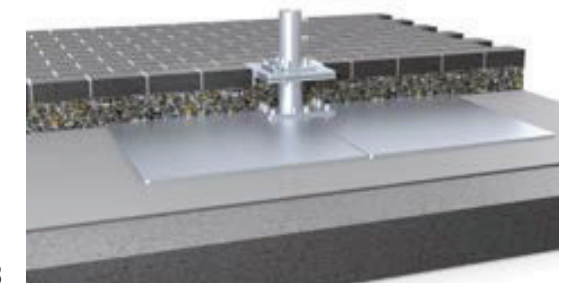

#### Theft pin

padlock and pin, in stainless steel, for support pole Ø 76 mm. suitable for retrofitting.

art. no. **200103**





## Premium parasol equipment for patios and smoking areas.

Parasols provide shelter from the sun and rain – a MAY premium parasol kit does more. Thanks to efficient lighting and infrared heating systems, this upmarket parasol concept for outdoor venues creates a warm and inviting ambience any time of the day and every season of the year. A feel-good environment created by maximum-comfort equipment helps to extend the outdoor season – your customers stay and enjoy. Moreover, you can offer them a comfortable smoking area outside. A place for smokers – a plus for your business!

### Wind shelter for smoking areas

With the help of side sheets, your giant parasol will become all-weatherproof and offer shelter from side winds. The polyester fabric is robust and durable and at the same time offers ample space for commercial branding of your choice. Several options are available: with or without windows, or with a continuous light belt. See page 192 onwards.

### Well-devised safety precautions

The use of electricity outdoors requires particularly careful safety measures. All our equipment materials and components are authorized for outdoor use and are splash-proof. To make sure the radiant heaters cannot be turned on while the parasol is closed, radiant heaters are secured by a three-step safety concept:

1. Main switch at the house
2. Rocker switch at each infrared heater
3. Sensor controlled, automatic cut out switch, art. no. 202051

### Modern efficiency

In terms of the current electricity costs this system is an insider's tip. In order to avoid unnecessary power consumption, each infrared radiant heater can be operated individually at its housing. The optional timer switch provides an additional saving possibility for smoking areas. The smoking person can activate the heater by the push of a button and after 15 minutes it shuts off automatically.

### Ultra-easy handling

Service staff will have no problems in handling our parasols. When installed with premium equipment, MAY parasols can easily be closed without prior removal of heaters or lights.

### Optimal heat range

The rays of the infrared heaters are emitted in thermal cones and thus form a protective belt of heat.

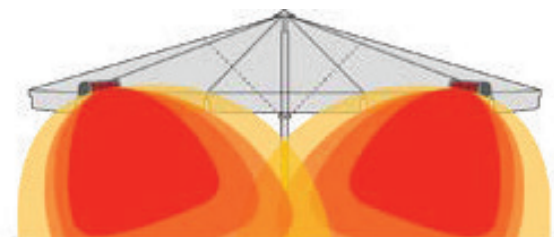

**Example of heaters and lights mounted on Type SCHATTELLO with anchor tube SZ150 KIT S 4 4A**



**Cabling, long**  
high-quality outdoor cabling, waterproof plug connections, protection class IP68.

**Electrical harness for current distributor**

**Cut-out switch**  
against heat overload when parasol is closed. Installation of **loud-speakers** also possible.

**Swivelling holder**  
for easy handling and adjustment.

**Slim lights**  
13 W, soft-white light, outdoor lighting, protection class IP65.

**Infrared heater**  
1,400 W.

**Power supply**  
within centre pole to avoid damage to cabling.

SCHATTELLO 5.0 x 5.0 m  
MayTex-Acryl SA 314 763 bordeaux

## Customized options and kit components

Compile your very own parasol equipment. As you can see from the list opposite, the kit components cover 9 main aspects.

For a made-to-measure solution just choose the equipment items that best suit your specific requirements.

1. Power supply
2. Current distribution
3. Mounting of heaters
4. Infrared heaters
5. Safety and energy-saving options
6. Slim lights
7. LED lighting
8. App for Bluetooth remote dimmer
9. Loudspeakers



SZ150

### 1. Power supply

#### Anchor tube with placement hinge

SCHATTELLO art. no. SZ150, ALBATROS art. no. AZ120

Underground power supply is the safest and neatest option. The cable inside the parasol centre pole simply needs to be connected to the underground cable on site. The connection itself is within the anchor tube and becomes invisible. The placement hinge makes the installation easy. There is no risk of damaging cables. SZ150 see page 112, AZ120 see page 172.



#### W-MAY 3-pole plug connector art. no. 352422

Connects the power supply within the centre pole (see art. no. 200369 below) with a flexible underground cable. Can be used to install up to 8 slim lights or 20 LED bars. Use only for stationary parasol installation bases (e.g. SZ150).

Delivery includes: plug, socket and socket end cap. For on-site mounting with screw terminals for wires 0.75 – 4.0 mm<sup>2</sup>, rigid and fine-wired. Clamping area of underground cable: 10 – 14 mm. IP68, 3-pole, 250 V, 20 A, -20 °C to 100 °C. Colour: black.



#### W-MAY 5-pole plug connector art. no. 200581

Connects the power supply within the centre pole (see art. no. 200369 below) with a flexible underground cable. Can be used to install up to 4 heaters together with 8 slim lights or 4 heaters together with 6 LED bars. Use only for stationary parasol installation bases (e.g. SZ150).

Delivery includes: plug, socket and socket end cap. For on-site mounting with screw terminals for wires 0.75 – 4.0 mm<sup>2</sup>, rigid and fine-wired. Clamping area of underground cable: Ø 13 mm to Ø 18 mm. IP66, 5-pole, 400 V, 20 A, - 20 °C to 100 °C. Colour: black.

#### SCHATTELLO and ALBATROS:

Due to lack of sufficient space, the 3-pole and 5-pole plug connectors listed above cannot be inserted together in the parasol centre pole. Should it become necessary to run 2 cables in one pole (e.g. additional cables for loudspeakers), one of the cables must be fixed firmly, for example, with a lustre terminal, H1 plug connector and shrink tubing.



#### External appliance plug art. no. 200582

Special care needs to be taken for parasols on a mobile pedestal base. This appliance plug with Cekon socket and integrated RCD ensures appropriate protection. 5-pole, 400V. However, not suitable for ALBATROS with full frame pedestal or for parasols with tubular motor.

#### Internal 2-circuit wiring art. no. 200587

Usually, parasols with heaters require a 400 V connection. If no high voltage current is available, 2 x 230 V cabling can be installed. In that case a maximum of 4 heaters and 6 LED bars can be fitted.

#### Power supply within centre pole art. no. 200369

Maximum safety is guaranteed by running the cabling through the support pole to the electrical harness. The risk of leakage or external hazards is thus minimized.

#### Power supply along one of the spokes art. no. 202052

Electric current can be run along a parasol spoke, provided there is a nearby socket in the wall of the house at a height of min. 2.3 m. It is always necessary to plug or unplug the parasol before opening or closing it. Make sure that the cable hanging from the parasol does not bother any guests or passers-by. When ordering, please enclose a sketch showing from which spoke the cable is to be run. Delivery includes: 1 m of cable to extend from a spoke end. Plug and socket not included.

## 2. Current distribution

#### Electrical harness

Full wiring in accordance with the circuit system is skilfully enclosed in this inconspicuous electrical harness – no cable tangle. Just another contribution to the overall elegance of the eye-catching parasol.



200565, IP44

#### Electrical harness SCHATTELLO art. no. 200565

Adapter art. no. 200567 is necessary for SCHATTELLO sizes 2 x 4 m, 2.5 x 3.5 m, 2.5 x 4 m, 2.5 x 5 m, 3 x 3 m, 3 x 4 m, 3 x 4.5 m, 3 x 5 m, 3 x 6 m, 4 x 6 m, 4 x 4 x 4 m, Ø 6 m 12 spokes.

#### Electrical harness ALBATROS art. no. 200566

#### Cabling

Current is run directly from the electrical harness to the heater via special plug connectors to VDE rubber-sheathed cables. This material is safer and more durable for outdoor use than PVC.

#### Cabling, long art. no. 200579

for swivelling holder art.no. 202040 (SCHATTELLO) and art. no. 200577 (ALBATROS).

#### Cabling, short art. no. 200585

for swift-fold spar art. no. 200578.





202040

### 3. Mounting of heaters

#### Swivelling holder

The heaters are fixed onto the end of a spoke with a swivelling holder. Thanks to this innovative, patented mechanism the heaters can be turned 90° and remain mounted when the parasol is closed. No tiresome mounting and dismounting when opening and closing the parasol.



rest position, turned by 90°



closing parasol

#### Swivelling holder SCHATTELLO art. no. 202040

Not suitable for 6 x 6 x 6 m with valance, Ø 3 m, Ø 4 m, Ø 5 m, 2 x 2 m, 2.5 x 2.5 m, 3.5 x 3.5 m, 2 x 3 m, 2 x 4 m, 2.5 x 3 m, 2.5 x 3.5 m and 4 x 4 m. Alternative: opt for swift-fold spar, art. no. 200578.

#### SCHATTELLO

Possible positions: Heater with swivelling holder

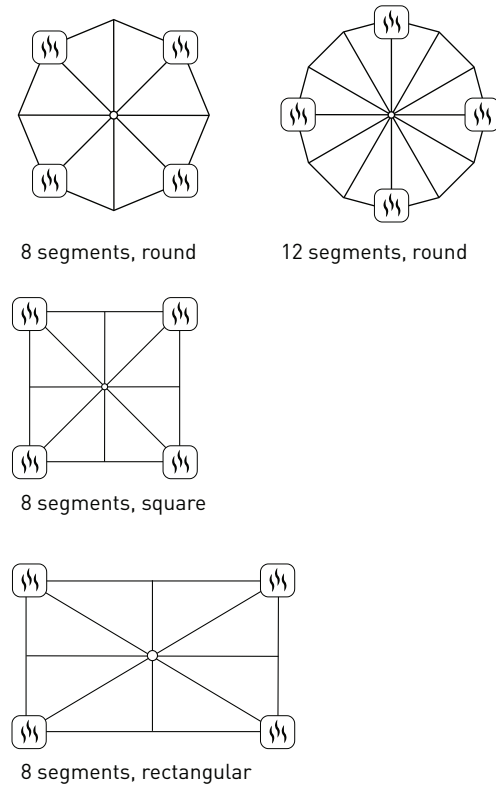

#### Swivelling holder ALBATROS art. no. 200577

Not suitable for Ø 4 m, Ø 4.5 m, Ø 5 m, Ø 5.5 m, Ø 6 m, Ø 7 m, 3.5 x 3.5 m, 3 x 4 m, 3 x 6 m, 3.5 x 7 m with valance, 4 x 8 m with valance and 5 x 5.85 m with valance. Alternative: opt for swift-fold spar, art. no. 200578.

#### ALBATROS

Possible positions: Heater with swivelling holder

4 heaters

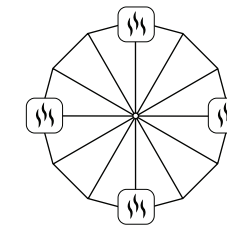

12 segments, round

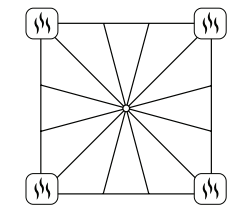

12 segments, square

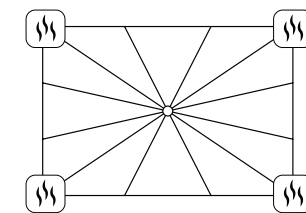

12 segments, rectangular

6 heaters

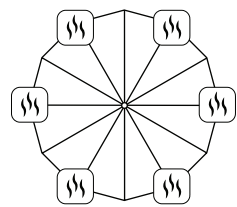

12-Teiler segments, round

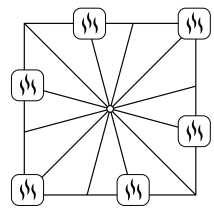

12 segments, square

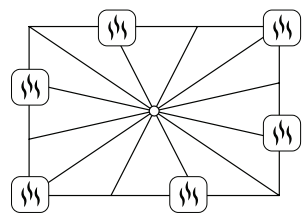

12 segments, rectangular

closed parasol with heaters and swivelling holder



200578

### 3. Mounting of heaters

#### Swivelling holder

The heaters are fixed onto the end of a spoke with a swivelling holder. Thanks to this innovative, patented mechanism the heaters can be turned 90° and remain mounted when the parasol is closed. No tiresome mounting and dismounting when opening and closing the parasol.



rest position, turned by 90°



closing parasol

#### SCHATTELLO

Possible positions: Heater with swift-fold spar

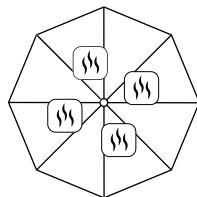

8 segments, round

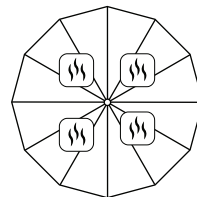

12 segments, round

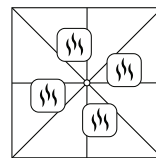

8 segments, square

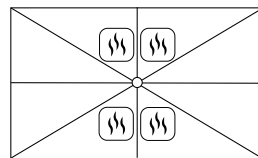

8 segments, rectangular

#### ALBATROS

Possible positions: Heater with swift-fold spar

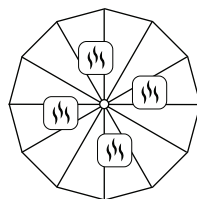

12 segments, round

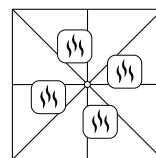

8 segments, square

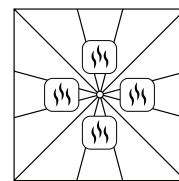

12 segments, square

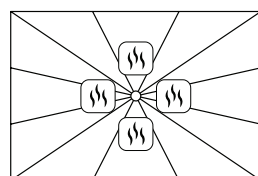

12 segments, rectangular

### 4. Infrared heaters

#### Infrared radiant heater 1,400 W art. no. 200430

Conventional heating systems warm up the air. The heat slowly evolves and is gradually transmitted to customers outside - at considerable expense. In bad weather conditions the warmth is blown away again before even reaching the customers. MAY infrared heaters warm only the surface at which they are directed, providing uniform, instant-on heat.

No energy- wasting warming-up process, so that customers very soon feel comfortably warm. Cosy warmth at the push of a button - in spite of any chilly breezes. All heaters have case-mounted switches.

Available in following colours: pure white RAL 9010, and white RAL 9006, fine structure / matt. With W-MAY plug; 230 V, 50 Hz, splash-proof IP24 (ENEC).



200430, IP24

### 5. Safety and energy-saving options

#### Automatic auxiliary cut out switch art. no. 202051

This automatic safety switch ensures that the heater cannot be accidentally switched on while the parasol is closed. Thus heat will not be able to accumulate under the canopy covering, then causing damage or even setting the whole parasol on fire.

#### Timer switch

Do you wish to keep the costs down at the smoking area? Your guests are able to activate the heater for about 15 minutes at the push of a button. A small button - an enormous (saving) effect.

art. no. 202050

#### Timer switch, by button at the electrical harness.

In case of a distributor flange position (with electrical harness) of more than 2 m height we recommend the timer switch, art. no. 353017.



202050



353017

art. no. 353017

#### Timer switch, by rocker switch at the support pole

In case of a distributor flange position (with electrical harness) of more than 2 m height we recommend the timer switch by rocker switch at the support pole. It is mounted at the support pole at a height of approximately 85 cm for a better access.

### 6. Slim lights

The luminous body of the slim lights is completely embedded in the enclosure and is thus well-protected for outdoor use. 4, 6 or 8 slim lights, each running at 13 W, can be fitted to the parasol. The soft-coloured lights are screwed directly onto the main spokes.

#### Slim light warm white art. no. 202090

2'700° K; 13 Watt; IP65; The T5 light tube is exchangeable.



202090



## 7. LED lighting

Energy-efficient LED light bars (12 Volt) subtly fitted on the underside of the spokes. The 60 high-performance LEDs per bar are extremely durable, dimmable, waterproof, shock-resistant and powered by an upstream power supply unit. The number of LED bars to be mounted and the colour of the light can be determined by you.

### PSU for 6 LED bars art. no. 351920

For the use of max. 6 LED bars on the parasol (each 12 V DC / 0.5 A). IP67; 90-260 V AC 50 / 60 Hz input; 12 V DC / 3.3 A output; temperature -40° to +70° C; air-cooled. If a tubular motor is to be used, the 6-connection power supply unit must be installed on the outside wall or inside the house. In that case an additional 12 V supply cable is needed for the parasol.

SCHATTELLO: Mounted on the telescopic pole at the factory.

ALBATROS: Installed in the electrical harness.

The combination "heaters + LED lighting + loudspeakers" is only possible with a 400 Volt supply cable. Moreover, in this case, a maximum of 6 LED bars can be installed. This is due to the limited space for cables in the parasol centre pole.

### PSU for 20 LED bars art. no. 350271

To be used with a maximum of 20 LED bars warm white (each 12 V DC / 0.5 A) or 27 LED bars RGB-ww (each 12 V DC / 0.4 A) at the parasol. IP65; 90-270 V AC 50 / 60 Hz input; 12 V DC / 11 A output; intern dimmable: 5.5-11 A; temp. -30° up to + 70° C; air-cooled.

SCHATTELLO and ALBATROS:

The power supply unit for 20 LED bars must be installed on the outside wall or inside the house. In that case an additional 12 V supply cable is needed for the parasol.

### Bluetooth remote dimmer v16-9 art. no. 352888

4 channels, 36 Watt / 12 Volt, for 12 LED-bars RGB-ww (colours and warm white) or 8 LED-bars warm white. Operated by Bluetooth and free app for iOS (> 5) or Android (> 4.3 with API-Level > 18). Please go to [www.may.ag/comp.pdf](http://www.may.ag/comp.pdf) to check the compatibility. The app lets you control several dimmers separately and save one colour permanently. Simply scan the QR code (see page 188) to download the app.

### Bluetooth remote control sender art. no. 352890

To control 2 Bluetooth remote dimmer with LED-bars RGB-ww (colours and warm white) or 4 Bluetooth remote dimmer with LED-bars warm white. (art. no. 352888).

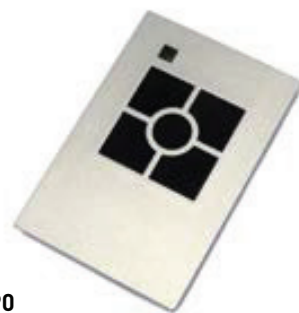

352890



352187

### LED bar, warm white art. no. 352187

3'000-3'500° K; 60 LEDs; 12 V DC / 0.5 A; LEDs power-controlled, fitted onto spoke; without spot optics, with diffuser.

### LED-bar RGB-ww (colours and warm white) art. no. 353925

LED-bar RGB-ww (red, green, blue, warm white 3'000-3'500° K); with 30 LEDs, 12V DC / 0.4 A, colour selection and dimming function by Bluetooth remote dimmer (art. no. 352888); classic LED spot optics with diffuser.

### Great light and impressive atmosphere

An LED bar with integrated light foil generates a diffuse, all-over illumination and therefore creates a nice and pleasant atmosphere.

### Simple operation

The colour cycle and the rate of colour change can be controlled by the Bluetooth remote control sender (art. no. 352890) or by the free app (see page 188).

### Light spectrum

The RGB-ww LEDs can create various colour combinations (see examples below).

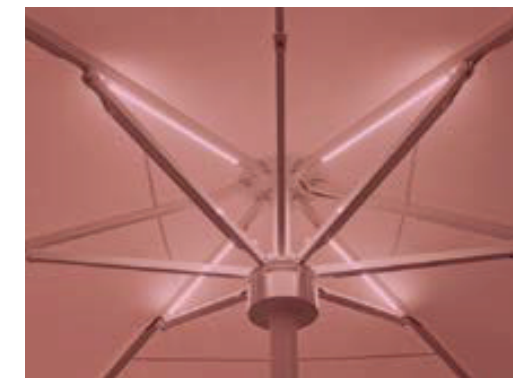
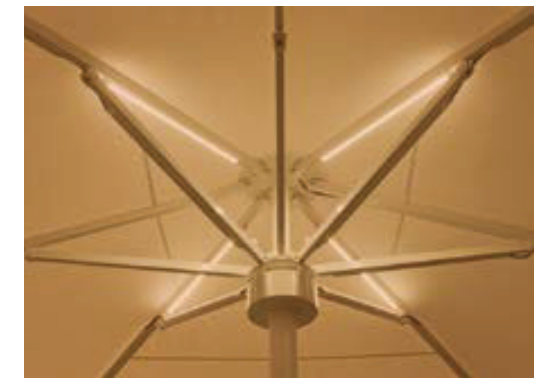
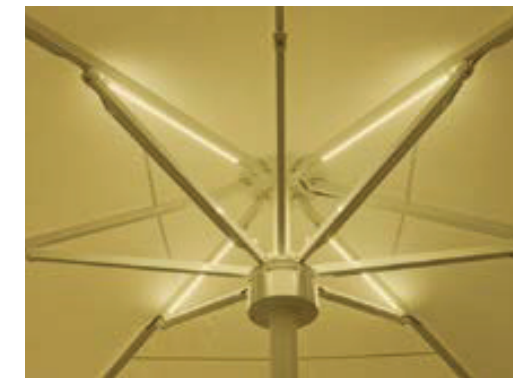

### 8. App for Bluetooth remote dimmer

The free app for Bluetooth remote dimmer is available for download at <https://www.may.ag/apps> or can simply be downloaded by QR code (shown on the left). The app is available for Android and iOS (Apple).

#### Simple operation

Easily mix various luminous colours and save individual light courses and brightness values by the app for Bluetooth remote dimmer. Additionally, the app provides a "switch-off comfort" that turns off the light after one minute automatically.



Use the app for Bluetooth remote dimmer to control and operate by smart phone. Use the shown QR code to download the free app.

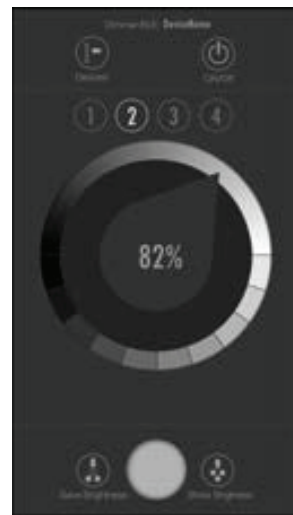

LED bar warm white dimming controller

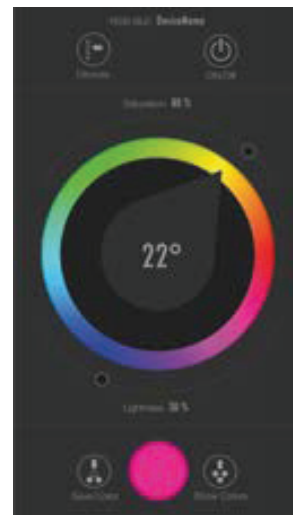

LED bar RGB-ww (colours and warm white) controller for colour cycle in %, brightness and dimmability

### 9. Loudspeakers

art. no. 202080

Offer pleasant background music to your guests. There are two outdoor loudspeakers neatly incorporated in the electrical harness and therefore weather protected and theft-proof.



The internal cable guide (through centre pole and anchor tube) protects the audio cable from weather effects and damaging. The parasol can be closed without demounting the loudspeakers. Each speaker provides 8 Watt peak performance and 8 Ohm impedance.

If more than one parasol is used, the speaker control must be adjusted individually or an ELA system is required (100 V technique). In case an ELA system is used, each parasol needs a 100 V transformer art. no. 353664.

#### 100 V transformer art. no. 353664

Required for the use of an ELA system. The parasols are supplied with a mono signal, therefore one 100V transformer is needed for each parasol, additionally to the two loudspeakers.







## Guide to IP protection classes

### Safety instructions:

Dimensioning and installation of electrical leads must be carried out by a certified electrician only. Always protect your parasol with RCD and automatic cut-out.

### Protection level of electrical components:

The quality of an electrified parasol largely depends on its level of protection. Think, for example, of squirting champagne or any similar unpredictable festivity occurrence and you will agree that "prevention is better than cure". The norm EN 60529 defines different classes or degrees of protection, so-called IP classes. (IP = International Protection).

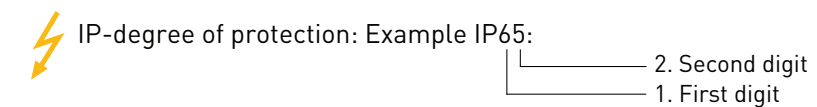

#### 1. First digit:

IP-degree:	Protection against contact	Protection against foreign objects
0	no protection	no protection
1	large-area parts of the body (e.g. back of the hand)	large foreign objects (Ø 50 mm)
2	finger	medium-sized foreign objects (Ø > 12 mm)
3	tools and wires (Ø > 2.5 mm)	small foreign objects (Ø > 2.5 mm)
4	tools and wires (Ø > 1 mm)	grain-shaped foreign objects (Ø > 1 mm)
5	complete protection against contact	dust deposits
6	complete protection against contact	compl. protection against penetration of dust

#### 2. Second digit:

IP-degree:	Water
0	no protection
1	protection against vertically falling drops of water
2	protection against drops of water coming from an angle of up to 15°
3	protection against spraying water hitting the vertical surface from an angle of up to 60°
4	protection against water splashing from all directions
5	protection against jets of water
6	protection against strong jets of water
7	protection against temporary submersion in water
8	protection against long periods of submersion in water

**\* NEW!**

## 10. USB charging station for new parasols orders

Are you thinking about how you may acquire more guests, how you may encourage them to come more often and on a regular basis?

An USB charging station at your MAY giant parasol, visible even from a distance, may offer an effective incentive. Up to 4 smartphones or tablets may be charged safely at the same time.

If your guests are feeling comfortable, the revenue per guest increases, your guests will be happy to visit your place again and will recommend the special service of your location.

Scope of delivery:

2 sockets for 2 smartphones each (4 x 1.5A; 5V DC), in a weather-proof housing, 4 theft-proof charging cables with 3 plug options for the most common smartphones (Micro-USB, USB Type C and Apple Lightning) as well as a black swan neck bracket.

The power supply cable (230V AC, 50Hz) for the USB charging station can be guided

- 1) along a spoke or
- 2) through the centre pole and installation base with a trough-bore for electrics.

The USB charging station can be combined with LEDs or heaters, however, a combination with motor drive, speakers or time switch is not possible.

**USB charging station for SCHATTELLO** art. no. 355714

**USB charging station for ALBATROS** art. no. 356274



3 plug charging cable

**Customized side sheet solutions**

Side sheets provide all-weather protection and ward off side-winds. The May-TEX Poly material is durable and can be imprinted with any graphic design of your choice. Several variations are available, e.g. without windows, with windows or with a continuous light belt.

- All side sheets are of May-TEX-Poly material.
- We recommend opting for parasols with valances if side sheets are to be used. Thus draughts through the space between the canopy and the side sheets can be avoided.
- Side sheets are fastened to the end of the spokes with specific holders. It will therefore be necessary to order holders number FA141, SA141 or AA141, depending on your parasol type.

	FILIUS	SCHATTELLO	ALBATROS
A300	•	•	•
A303	•	•	•
A306	•	•	•
A309	•	•	•
A312	•	•	
A315	•	•	
Roll-up door	•	•	•



Side sheet holder

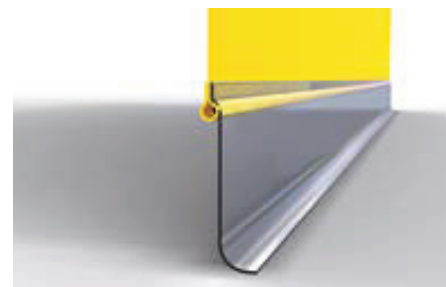

Variable bottom end of side sheet



Aluminium rod in textile pocket



Installation of side sheet variations A300 and A303

The side sheets shown below extend across one side of the parasol and are fastened to the spokes.

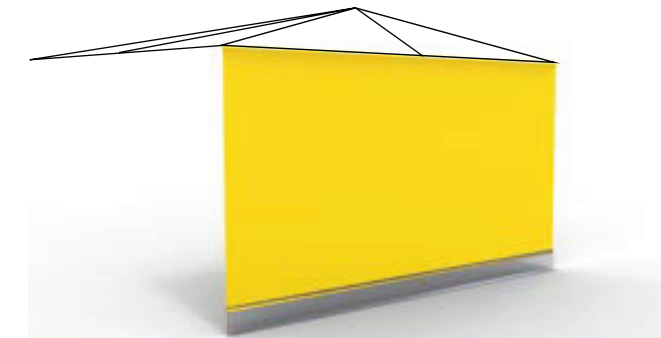

A300

Side sheet without windows

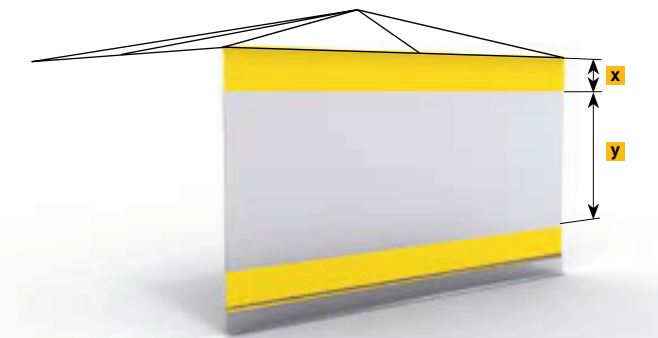

A303

Side sheet with continuous light belt

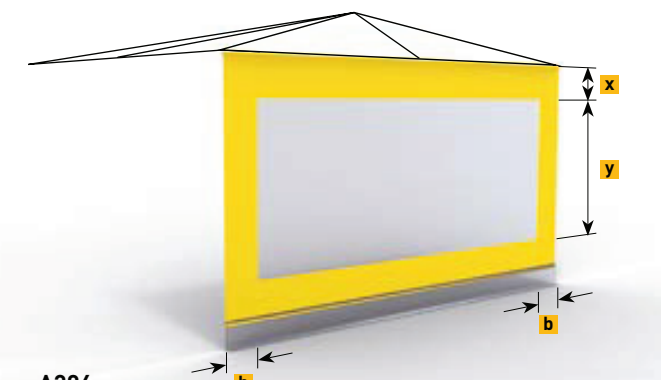

A306

Side sheet with one window across one roof side

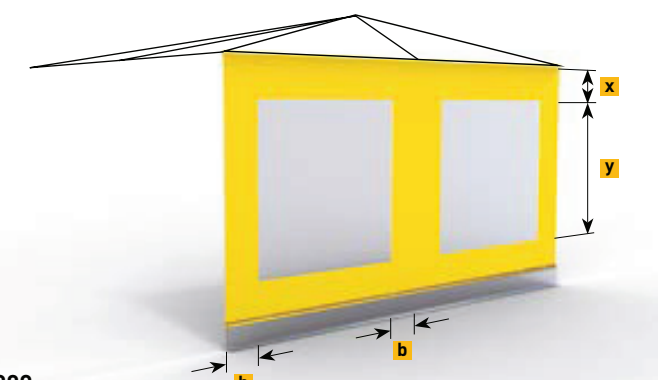

A309

Side sheet with one window per roof segment

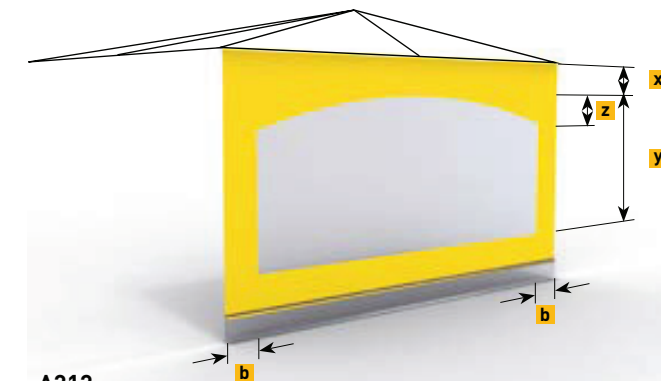

A312

Side sheet with one arched window across one roof side

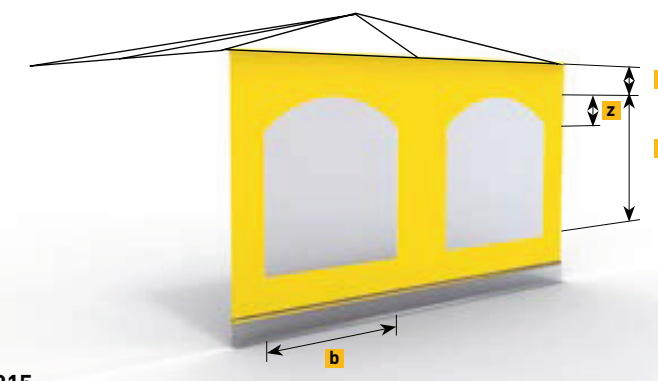

A315

Side sheet with one arched window per roof segment

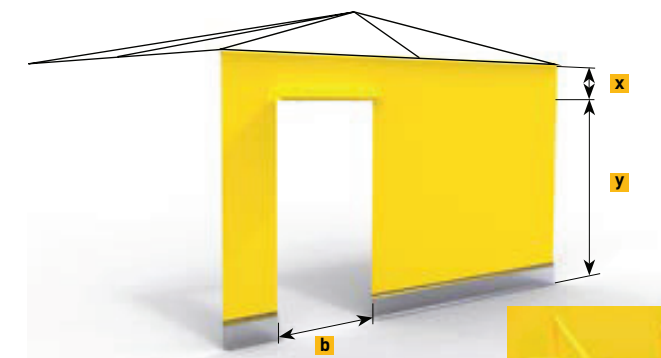

Roll-up door

Side sheet with roll-up door. Only possible in combination with variations A300 or A303.



	x in cm	y in cm	z in cm	b in cm
A303	35	135		
A306	35	135		30
A309	35	135		30
A312	35	135	25	30
A315	35	135	25	120
Roll-up door	35	200		100



## MayTex-Acryl with Texgard impregnation

- material: 100% polyacrylic, spun-dyed, weight 300g/m<sup>2</sup> ±5%
- water column (fabric water tightness) 370 mm, European standard EN 20 811
- colour fastness: grade ≥7 (against bleaching), tested acc. to standard EN ISO 105-B02 (1= min., 8= max.)
- colour fastness to artificial weathering: grade ≥4-5 (against bleaching), tested acc. to standard EN ISO 105-B04 (1= min., 5= max.)
- protection against UV rays: UPF 40-80, tested acc. to UV standard 801 (see page 201 for individual values)

- weather-proof, high and low temperature resistant
- Texgard impregnation gives effective protection against oil, grease, mildew and algae, industrial pollution, exhaust fumes and other negative environmental factors
- tested acc. to OEKO-TEX Standard 100 (63864 OETI, QC 638/2 IFTH)
- imprinted ads: on parasol canopy and valance in durable, brilliant screen-printing quality
- cleaning: easy to clean with CleanoMay 13, even when mounted

The shades shown here are not in accordance with the original ones. If requested, we will be pleased to send you a collection of original cloth samples. Special colours are available upon request.



SA 314 010 white  
similar to RAL 9003  
bordering 00 white



SA 314 018 white, grey knopped  
similar to RAL 9016  
bordering 00 white

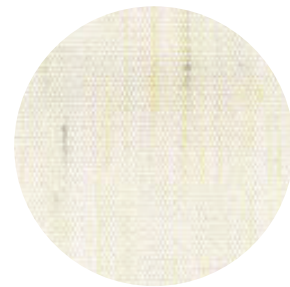

SA 314 580 white, yellow/white nap  
similar to RAL 9002  
bordering 18 silver



SA 314 325 ecru  
similar to RAL 1013  
bordering 52 nature

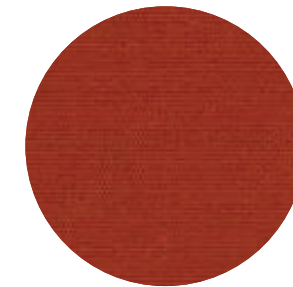

SA 314 022 rust  
similar to RAL 2001  
bordering 83 rust

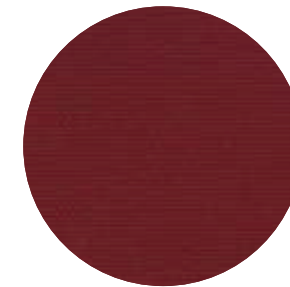

SA 314 763 bordeaux  
similar to RAL 3004  
bordering 86 bordeaux

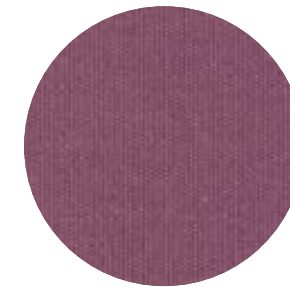

SA 314 143 mallow  
similar to RAL 4001  
bordering 91P mallow

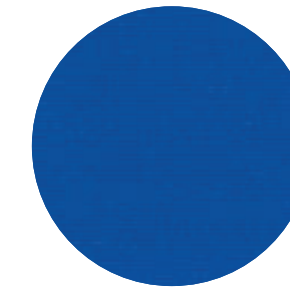

SA 314 011 royal blue  
similar to RAL 5010  
bordering 62 royal blue



SA 314 851 vanilla  
similar to RAL 1015  
bordering 20 ivory

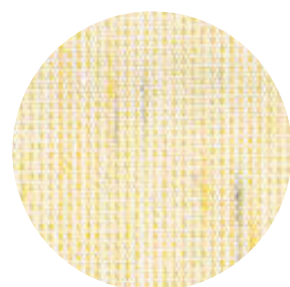

SA 314 583 white/yellow, grey knopped  
similar to RAL 1023/1013  
bordering 20 ivory

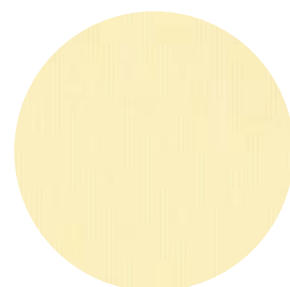

SA 314 033 ivory  
similar to RAL 1013  
bordering 20 ivory

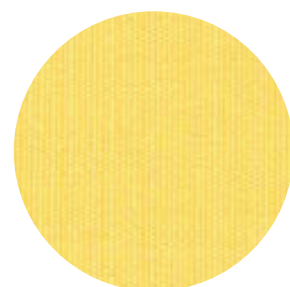

DA 7560 light yellow  
similar to RAL 1023  
bordering 10 pyrite

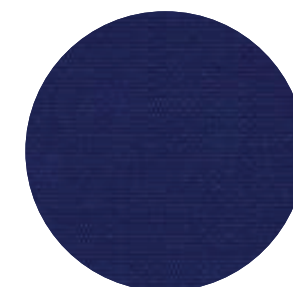

SA 314 006 sapphire  
similar to RAL 5002  
bordering 66 sapphire

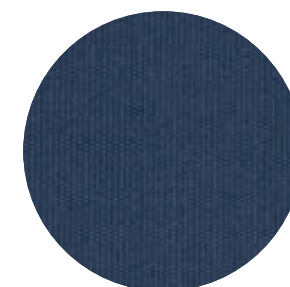

SA 314 546 patina blue  
similar to RAL 5007  
bordering 187 blue patina

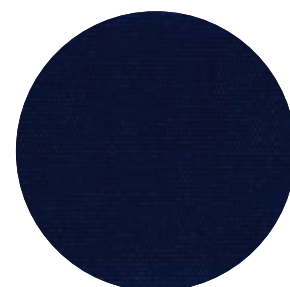

SA 314 414 navy blue  
similar to RAL 5013  
bordering 91 navy blue



DA 7244 lime green  
similar to RAL 6018  
bordering 42 lime green

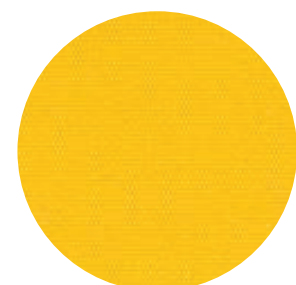

SA 314 003 yellow  
similar to RAL 1023  
bordering 32 yellow

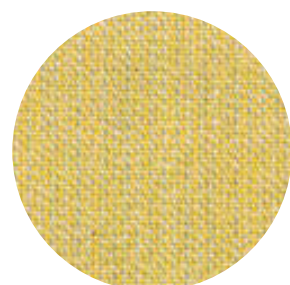

SA 314 045 pyrite  
similar to RAL 1002  
bordering 10 pyrite

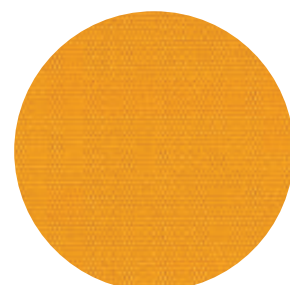

SA 314 014 mandarine  
similar to RAL 1033  
bordering 79 mandarin

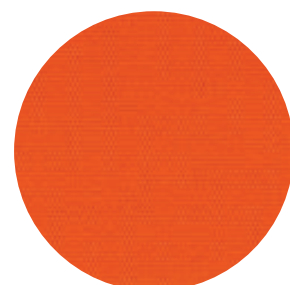

SA 314 002 orange  
similar to RAL 2004  
bordering 81 orange

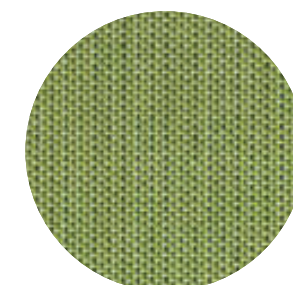

SA 314 396 green/apple green, structured  
similar to RAL 6021  
bordering 42 lime green

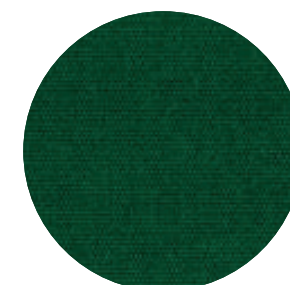

SA 314 362 dark green  
similar to RAL 6005  
bordering 95 dark green

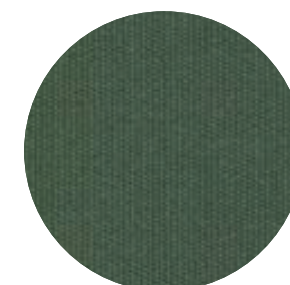

SA 314 624 patina green  
similar to RAL 6000  
bordering 162 green patina

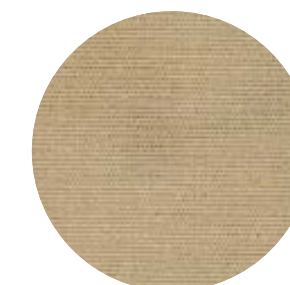

SA 314 038 beige  
similar to RAL 1019  
bordering 11 beige

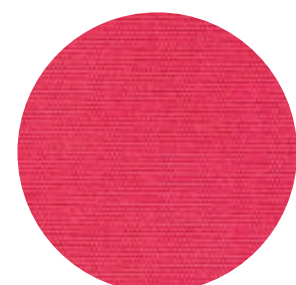

SA 314 397 magenta  
similar to RAL 4010  
bordering 410 magenta



SA 314 007 pure red  
similar to RAL 3028  
bordering 82 red

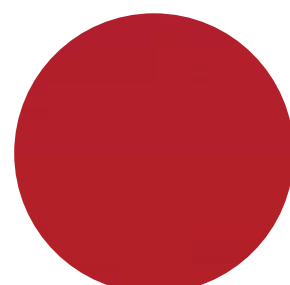

SA 314 001 cherry  
similar to RAL 3020  
bordering 85 cherry

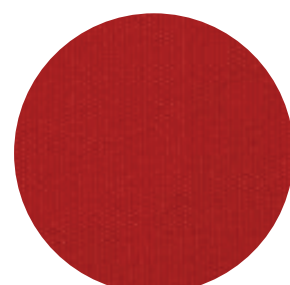

SA 314 347 ruby  
similar to RAL 3003  
bordering 85 cherry

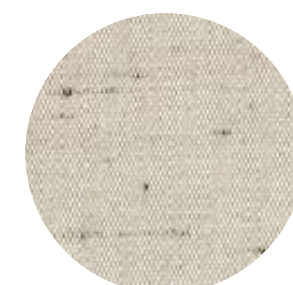

SA 314 471 silver grey, dark brown knopped  
similar to RAL 1013/7006  
bordering 18 silver

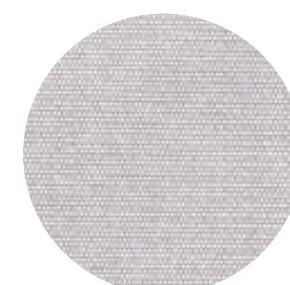

SA 314 030 light grey  
similar to RAL 7047  
bordering 18 silver

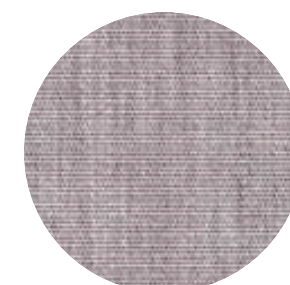

SA 314 028 stone grey, mottled  
similar to RAL 7042  
bordering 18 silver

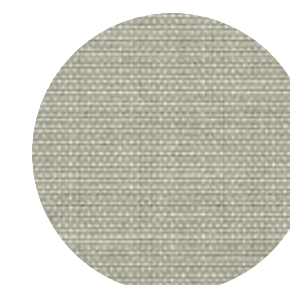

SA 314 044 grey-white  
similar to RAL 7004  
bordering 18 silver



## MayTex-Acryl with Texgard impregnation

- material: 100% polyacrylic, spun-dyed, weight 300g/m<sup>2</sup> ±5%
- water column (fabric water tightness) 370 mm, European standard EN 20 811
- colour fastness: grade ≥7 (against bleaching), tested acc. to standard EN ISO 105-B02 (1= min., 8= max.)
- colour fastness to artificial weathering: grade ≥4-5 (against bleaching), tested acc. to standard EN ISO 105-B04 (1= min., 5= max.)
- protection against UV rays: UPF 40-80, tested acc. to UV standard 801 [see page 201 for individual values]

- weather-proof, high and low temperature resistant
- Texgard impregnation gives effective protection against oil, grease, mildew and algae, industrial pollution, exhaust fumes and other negative environmental factors
- tested acc. to OEKO-TEX Standard 100 (63864 OETI, QC 638/2 IFTH)
- imprinted ads: on parasol canopy and valance in durable, brilliant screen-printing quality
- cleaning: easy to clean with CleanoMay 13, even when mounted

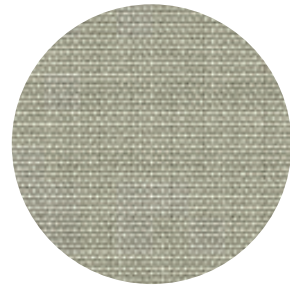

SA 314 364 telegrey/white  
similar to RAL 7046  
bordering 147 opal



DA 8779 olive brown  
similar to RAL 7002  
bordering 9533 olive brown

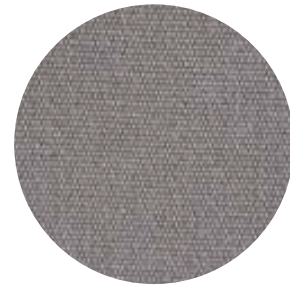

DA 7559 taupe  
similar to RAL 7006  
bordering 926 taupe

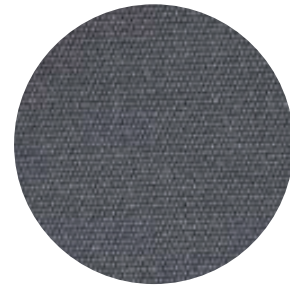

DA 8203 basalt grey  
similar to RAL 7010  
bordering 97 grey basalt



SA 314 398 atlas grey  
similar to RAL 7043  
bordering 97 grey basalt

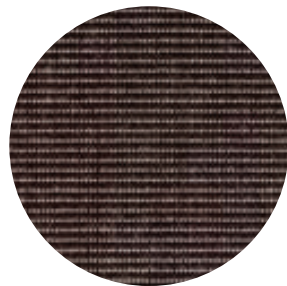

SA 314 402 black/beige,  
structured  
similar to RAL 6006  
bordering 19 black



SA 314 016 dark brown  
similar to RAL 8017  
bordering 27 dark brown



SA 314 154 black  
similar to RAL 9017  
bordering 19 black

The shades shown here are not in accordance with the original ones.  
If requested, we will be pleased to send you a collection of original cloth samples.  
Special colours are available upon request.

## MayTex-Poly

- material: 81% polyester, 19% polyacrylics, weight 230 g/m<sup>2</sup> ± 5%
- water column (fabric water tightness) 1000 mm, European standard EN 20 811
- colour fastness: grade ≥7 (against bleaching), tested acc. to standard EN ISO 105-B02 (1= min., 8= max.)
- protection against UV rays: UPF80, tested acc. to UV standard 801 [see page 201 for individual values]

- Texgard impregnation gives effective protection against oil, grease, mildew and algae, industrial pollution, exhaust fumes and other negative environmental factors
- tested acc. to OEKO-TEX Standard 100 (63864 OETI)
- imprinted ads: on parasol canopy and valance in durable, brilliant screen-printing quality
- cleaning: easy to clean with CleanoMay 13, even when mounted



M 9577 white  
similar to RAL 9010  
bordering 00 white



M 9823 ivory  
similar to RAL 1015  
bordering 20 ivory



M 9875 creme  
similar to RAL 1015  
bordering 11 beige



M 9816 sand  
similar to RAL 1001  
bordering 10 pyrite

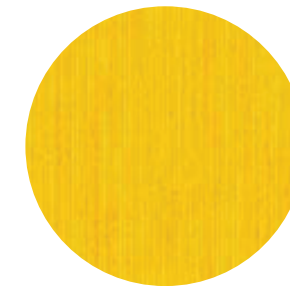

M 9526 bright yellow  
similar to RAL 1023  
bordering 32 yellow

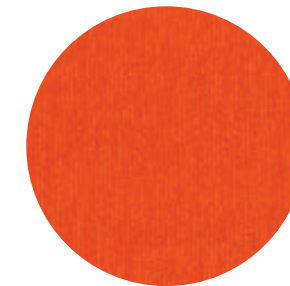

M 9527 orange  
similar to RAL 2004  
bordering 81 orange

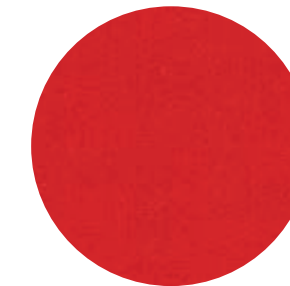

M 9671 red  
similar to RAL 3020  
bordering 82 red

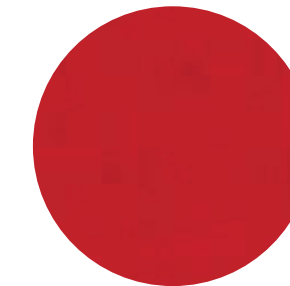

M 9675 cherry red  
similar to RAL 3000  
bordering 85 cherry

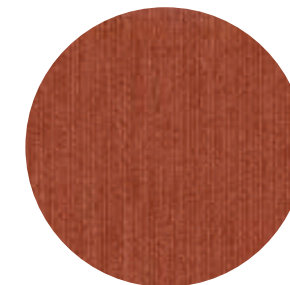

M 9878 terracotta  
similar to RAL 8004  
bordering 83 rust

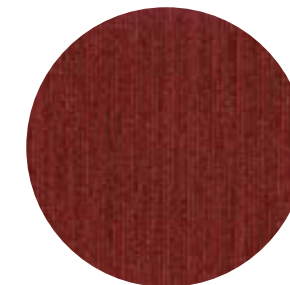

M 9879 bordeaux  
similar RAL 3004  
bordering 86 bordeaux

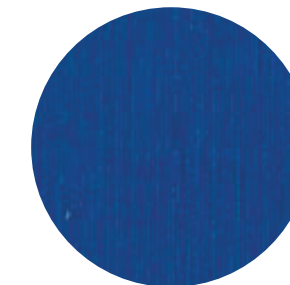

M 9793 bright blue  
similar to RAL 5005  
bordering 63 blue

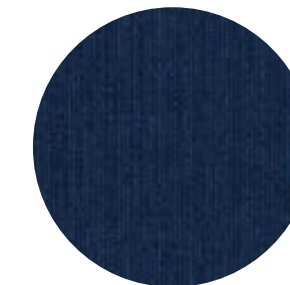

M 9545 dark blue  
similar to RAL 5003  
bordering 91 navy blue

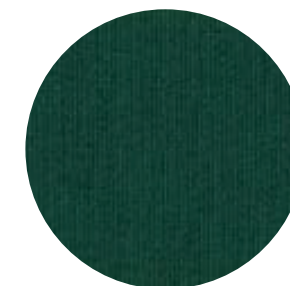

M 9710 woodland green  
similar to RAL 6005  
bordering 95 dark green

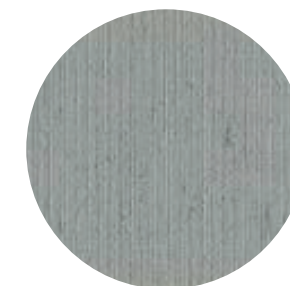

M 9653 grey  
similar to RAL 7004  
bordering 18 silver



M 9654 graphite grey  
similar to RAL 7024  
bordering 97 grey basalt

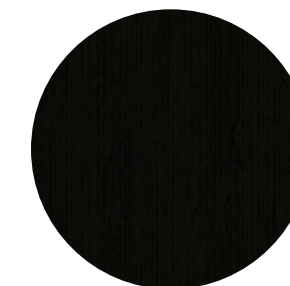

M 9853 black  
similar to RAL 9004  
bordering 19 black



## MayTex-PVC

- material: 71% chlorofibre, 29% polyester, weight 480 g/m<sup>2</sup> ± 5%
- water column (fabric water tightness) > 1000 mm, European standard EN 20 811
- colour fastness: grade ≥ 7 (against bleaching), tested acc. to standard EN ISO 105-B02 (1= min., 8= max.)
- flammability "flame retardant" (without printing):
  - "B1" German standard DIN 4102-1
  - "M2" French standard NF P 92-503
  - "CL2" Italian standard CL UNI 9177



302 239 white matt  
similar to RAL 9016  
bordering 00 white



302 237 ecru matt  
similar to RAL 1013  
bordering 52 nature



302 241 ivory matt  
similar to RAL 1015  
bordering 20 ivory



302 544 beige matt  
similar to RAL 1001  
bordering 11 beige

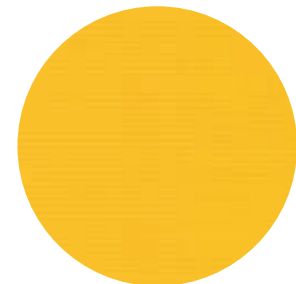

302 199 yellow  
similar to RAL 1003  
bordering 32 yellow

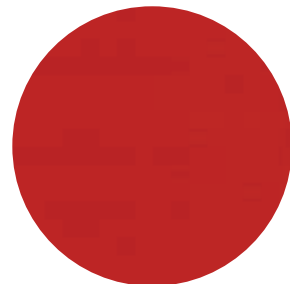

302 255 red  
similar to RAL 3020  
bordering 82 red



302 236 bordeaux matt  
similar to RAL 3005  
bordering 86 bordeaux

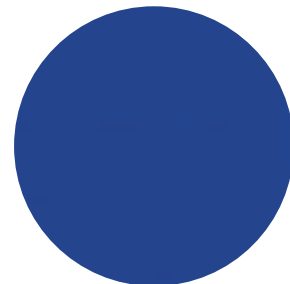

302 001 blue  
similar to RAL 5005  
bordering 62 royal blue



302 814 green matt  
similar to RAL 6005  
bordering 95 dark green

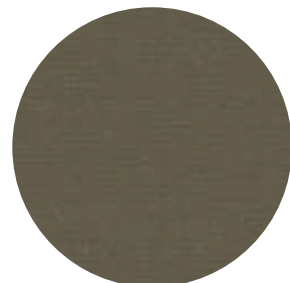

302 165 beige grey matt  
similar to RAL 7006  
bordering 9533 olive brown

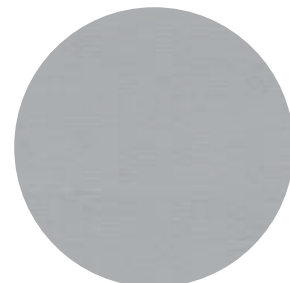

302 331 grey matt  
similar to RAL 7004  
bordering 18 silver

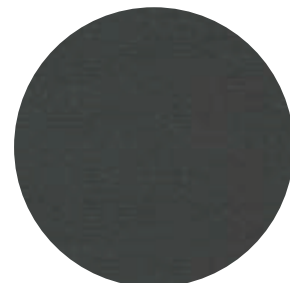

302 378 slate grey matt  
similar to RAL 7015  
bordering 97 grey basalt

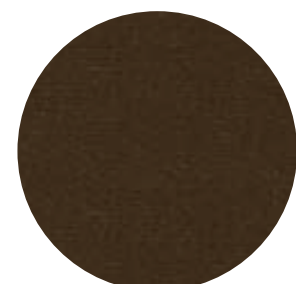

302 328 dark brown matt  
similar to RAL 8017  
bordering 27 dark brown



302 405 black matt  
similar to RAL 9004  
bordering 19 black

- protection against UV rays: UPF80, tested acc. to UV standard 801 (see page 201 for individual values)
- Texgard impregnation gives effective protection against oil, grease, mildew and algae, industrial pollution, exhaust fumes and other negative environmental factors
- in accordance with REACH
- 100% recyclable (to be returned to May Gerätebau GmbH)
- imprinted ads: on parasol canopy and valance in durable, brilliant screen-printing quality
- cleaning: easy to clean with CleanoMay 13, even when mounted

On request we can also supply parasols for indoor use with further flame retardant fabrics acc. to DIN 4102-1 B1 (only available without screen print).

The shades shown here are not in accordance with the original ones. If requested, we will be pleased to send you a collection of original cloth samples. Special colours are available upon request.

## Borderings

If no colour is specified, a binding tape will be chosen to match the cloth.



00 white



20 ivory



52 nature

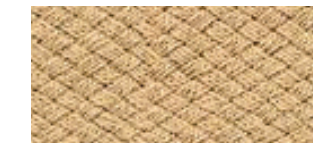

11 beige



32 yellow

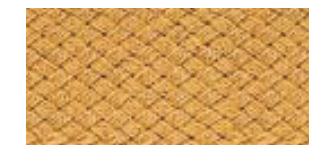

10 pyrite



79 mandarin



81 orange

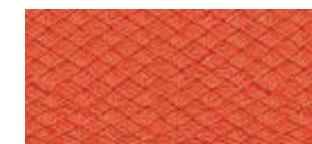

148 terracotta

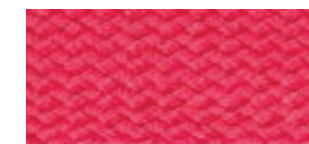

410 magenta



82 red



85 cherry



83 rust

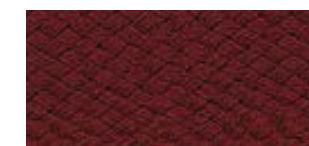

86 bordeaux

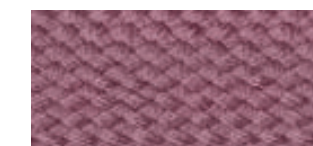

91P mallow



62 royal blue



63 blue



187 blue patina

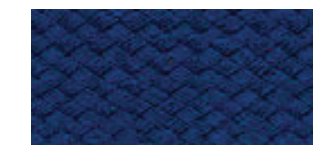

66 sapphire

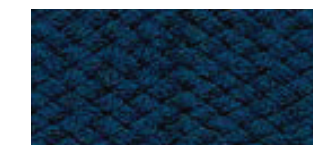

91 navy blue



42 lime green



44 grass-green

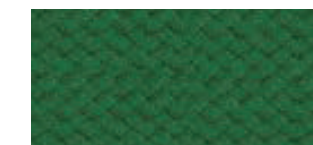

162 green patina

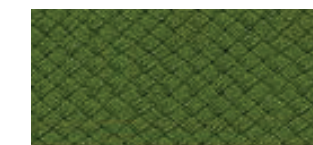

45 olive



95 dark green

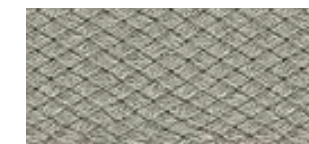

18 silver



147 opal

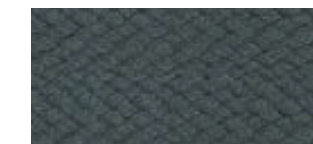

97 grey basalt

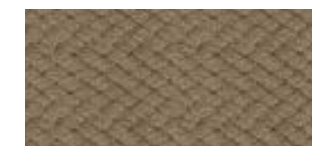

926 taupe

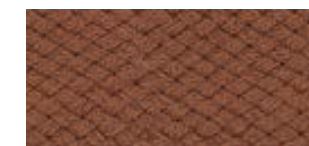

25 light brown

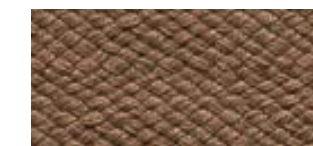

9533 olive brown



27 dark brown

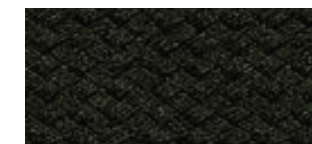

19 black

The textile finishing of a parasol canopy – i.e. the fabrics – is not only the most important and most conspicuous feature of any sun protection system, it also fulfils numerous functions:

### Colour, light and shade: personal well-being, atmosphere and decoration

The comprehensive range of upmarket classics and specialities. The fabric keeps out the light. It protects, shades, creates atmosphere and serves as an element of design and decoration. The fabric evokes a sense of harmony and creates a feeling of well-being by filtering and tinting the light and thus lending a room and its environment a very special soothing atmosphere. The impact a fabric has on a person is decisively determined by its colour, pattern and degree of translucence.



**Harmony and Inner peace** through well-balanced colours and natural shades of colour.



**Joie de vivre** through vibrant colours.

### Healthy shade provider, protection from harmful UV radiation

The sun is a source of life and its light provides our bodies with essential vitamins, but it can also be very dangerous. Studies by the WHO indicate a threefold increase in skin diseases caused by harmful UV radiation. The UV Protection Factor (Sun Protection Factor) of our fabrics is a unit that indicates to what extent they increase the human skin's

natural protection time to direct sunlight. The length of the natural protection of human skin depends on the skin type. The following textiles in our collection have been tested and certified according to the latest and most stringent standard UV 801.

	Sun Protection Factor			Effect on personal well-being	
	PROTECT 40 UV STANDARD 801 Test-No. 35120 ÖTI GmbH	PROTECT 60 UV STANDARD 801 Test-No. 33282 ÖTI GmbH	PROTECT 80 UV STANDARD 801 www.uvstandard801.com 19.1.10.0049-00-1 Hohenstein 19.1.10.0049-00-2 Hohenstein Test-No. 35122 ÖTI GmbH Test-No. 74088 ÖTI GmbH	Joie de vivre	Inner peace
<b>MayTex-Acryl UNI</b>					
SA 314 001, SA 314 002, SA 314 003, SA 314 007, SA 314 011, SA 314 014, SA 314 143, SA 314 396, SA 314 397, DA 7560			80	•	
SA 314 006, SA 314 016, SA 314 022, SA 314 028, SA 314 038, SA 314 044, SA 314 045, SA 314 154, SA 314 347, SA 314 362, SA 314 364, SA 314 398, SA 314 402, SA 314 414, SA 314 546, SA 314 624, SA 314 763, SA 314 851, DA 7244, DA 7559, DA 8203, DA 8779			80		•
SA 314 030, SA 314 325, SA 314 471, SA 314 583		60			•
SA 314 010, SA 314 018, SA 314 033, SA 314 580	40				•
<b>MayTex-Poly</b>			80		
<b>MayTex-PVC</b>			80		

### How high is your personal protection factor? Type 1-6

Type	Characteristics	Reaction of the unprotected skin to 30 mins. radiation in June	The human skin's natural protection time	Protection time of the skin when shaded by a parasol		
				PROTECT 40 UV STANDARD 801 Test-No. 35120 ÖTI GmbH	PROTECT 60 UV STANDARD 801 Test-No. 33282 ÖTI GmbH	PROTECT 80 UV STANDARD 801 www.uvstandard801.com 19.1.10.0049-00-1 Hohenstein 19.1.10.0049-00-2 Hohenstein Test-No. 35122 ÖTI GmbH Test-No. 74088 ÖTI GmbH
1	light skin, freckles, fair or red hair, blue or green eyes	always sunburn no tan	5-10 minutes	200-400 minutes	300-600 minutes	400-800 minutes
2	light skin, fair hair, blue or green eyes	always sunburn a slight tan	10-20 minutes	400-800 minutes	600-1200 minutes	800-1600 minutes
3	dark hair, blue eyes	slight sunburn a good tan	20-30 minutes	800-1200 minutes	1200-1800 minutes	1600-2400 minutes
4	dark skin, dark or black hair, brown eyes	no sunburn a good tan	approx. 45 minutes	approx. 1800 minutes	approx. 2700 minutes	approx. 3600 minutes
5	dark skin, black hair, dark eyes	no sunburn	approx. 60 minutes	approx. 2400 minutes	approx. 3600 minutes	approx. 4800 minutes
6	black skin, black hair, black eyes	no sunburn	approx. 90 minutes	approx. 3600 minutes	approx. 5400 minutes	approx. 7200 minutes

Source: Krebsliga Schweiz / Cancer Association Switzerland. www.krebsliga.ch



## Product properties of fabrics

Parasol cloths are high-performance products. However, given the requirements that have to be met in the field of environmental protection, there is a limit to the degree of perfection that can be achieved in spite of present-day state-of-the-art production and processing. As a result, customers may occasionally lodge complaints regarding certain features that can appear on the cloth. Such features neither alter the value of the product, nor do they impair its usability in any way. As we feel committed to providing full consumer information and thus hope to avoid irritation or dissatisfaction, we should like to draw your attention to the following features:

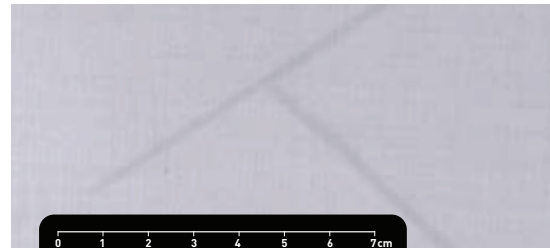

### Crease marks

Crease marks may appear during the production process or when folding the parasol fabric. When held against the light, cloths – particularly those of a light colour – may appear to have a dark streak in the crease.

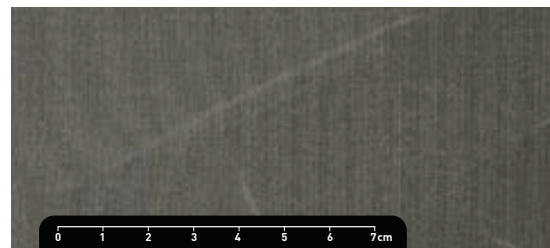

### Chalk effect

Light chalk-like stripes may arise during the processing of materials. Although the greatest of care is taken, they cannot always be totally avoided.

### Water/rain resistance

Acrylic canopy covering are impregnated with a water-repelling finish and can withstand short periods of light rainfall if treated with proper care. During lengthy periods of rainfall or heavy downpours, however, the parasol should remain closed in order to prevent any material damage. If the cloth becomes wet, the canopy covering should be opened again as soon as possible to allow it to dry.

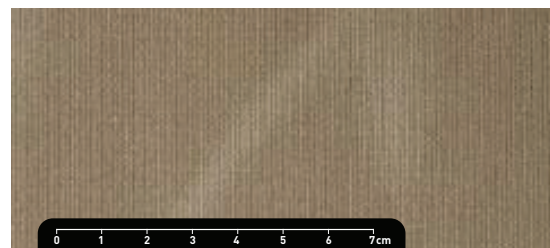

### Abrasion marks

In the course of time abrasion may weaken the canopy fabric and thus impair its quality. This can be avoided by pulling the cloth between the spokes when closing the parasol and then securing it with a yellow strap to prevent flapping.



### Cleaning instructions

Stains can be cleaned off with a soft brush and CleanoMay 13. Rinse well afterwards with clean water to remove all detergents from the fabric. A high-pressure hose may be used for large-area surfaces (max. 30° C, max. 30 bar, min. distance from canopy covering 30 cm, cleaner: CleanoMay 13, 1 litre concentrate yields 26 litres liquid cleanser).

### Characteristic features of our sewing yarn:

- high tensile strength
- optimum abrasion resistance
- well-balanced elongation property
- high thermal resilience
- good light and weather fastness

### Alternating segment colours

Alternating segment colours are available as illustrated.

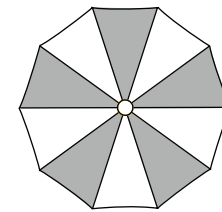

1/8-division

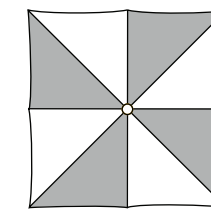

1/8-division

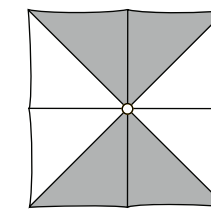

1/4-division

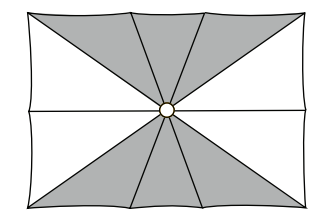

1/4-division

### Bordering

The canopy covering is trimmed with high-quality polyacrylic edge binding. If not specified otherwise, the border will be chosen to match the colour of the canopy fabric. For special optical accents you may also choose the canopy and binding in contrasting colours.



FILIUS ø 3 m, MayTex-Acryl SA 314 014 mandarine, Bordering in 18 silver





### The concept

Upgrade your giant parasol to gain maximum stability. The parasol roof stabiliser supports the spokes at the outer edge, right where the highest forces are acting on. The drag and compressive forces of the wind are absorbed and so the giant parasol gains enormous stability.

### Field of application

The parasol roof stabiliser is your solution if your parasol should remain open even during stronger winds. This is especially interesting for exposed areas such as open terraces, coastal areas or top floors of office or industrial buildings.

### Sustainability

A giant parasol that is equipped with parasol roof stabilisers can withstand stronger winds. Therefore, this reduces the movements of the spokes and so increases the durability. These are your benefits:

1. Extended durability conserves resources and protects the environment. Decide for a higher investment that pays off long-term.
2. Worldwide the climate warming causes extreme weather events. The more stable an installation is built the better it can withstand these challenging environmental conditions.

### More revenue

The parasol roof stabilisers reinforce a giant parasol so it can be used almost throughout the year. High stability provides optimal all-weather protection and so helps to increase revenue in the gastronomy sector. A benefit in all respects.

## General Information

### Wind-resistant side sheets

Even with smaller parasol models side sheets sometimes have to withstand high wind pressures. The weight of the side sheets also puts force on a giant parasol. Parasol roof stabilisers are able to absorb these forces. Additionally, side sheets can firmly be tied down to the floor without putting additional force onto the parasol. Therefore, parasol roof stabilisers enable you to protect even larger areas for your customers.

### Stabilisation levels

Four parasol roof stabilisers attached to the diagonal spokes, reinforce the basic stability of a giant parasol at a reasonable price. The optimum is reached if all spokes are supported by parasol roof stabilisers. Due to the modular design you can easily upgrade from four spokes to all spokes.

### Keep calm and brave the wind

Up to 200 kg of drag and compressive forces of the wind can be absorbed in axial direction.





## Upper fixation

clamping with flexible ball knob



see page 207

## Upper fixation

Aluminium profile in EV1 silver-grey, white ball socket.

suitable for SCHATTELLO  
suitable for ALBATROS

article no. **354100**  
article no. **354102**



## Parasol roof stabiliser

thread bar with cross bolt and ball socket



see page 207

## Initial installation

The "upper fixation" is firmly glued to the aluminium spoke during initial installation. Therefore, it remains attached also for opening and closing of the giant parasol.



double clamping  
1. quick lock 2. fixed installation



see page 208

## Automatic adjustment

The ball housing of the ball socket adjusts itself to each spoke automatically during installation (on main axis) – independent from its angle of slope. There is no complicated setting or adjustment. Therefore, the parasol roof stabilisers can be flexibly used for any spoke during installation.



## Bottom fixation

DMZ installation option



see page 209

## Parasol roof stabiliser

Standard length, telescoping system, aluminium EV1 silver-grey, base mast outer-Ø 55 x 3 mm, telescopic tube outer-Ø 48 x 4 mm, total length retracted 165 cm, total length extended 285 cm.

suitable for SCHATTELLO and ALBATROS

article no. **354104**



## Bottom fixation

### Initial installation

„Bottom fixation“ stands for the anchoring with the ground. Basically all FILIUS installation options can be used, therefore all options whose article numbers start with „DMZ“.



DMZ261

### The bottom tube below ground

The DMZ118 bottom tube is a permanent installation and remains in the ground, no matter if the parasol roof stabiliser is mounted or demounted.



DMZ118

### The upper tube

This component can be used temporarily as well as permanently. The upper tube can be removed when demounting the parasol roof stabiliser. The supplied winter cover makes the bottom part trip-proof. Therefore, there is no risk of accidents or injuries.



DMZ118

The upper tube can also remain mounted even if the parasol roof stabiliser is demounted. This saves assembly time. However, the risk of injuries is at owner's risk.



DMZ118

### Uneven terrace floor

Does the parasol stand on a lightly sloping terrace? Do you want to install the base evenly to avoid tripping hazards during disassembly? This is absolutely no problem. The telescoping mechanism levels out different heights. Due to the infinite clamping, the parasol roof stabilisers even are interconvertible. There is no need of marking as they can be used flexibly for any spoke.

### Easy installation and suitability for gastronomy

The parasol roof stabiliser is designed for a quick and easy assembly and disassembly. There are no special tools required.

There are two fixation options for the clamps. The components for both options are supplied with each standard delivery.

1. Quick lock: For daily opening and closing, the parasol roof stabiliser can easily be removed by handle.
2. Fixed installation: The clamps can be fixed with hexagon screws if the parasol remains open for a longer period of time or if opening by unauthorised persons should be avoided.

### Connecting elements

All connecting elements of the parasol roof stabiliser are designed to have zero clearance. This avoids mechanical clacking in case of wind and so your guests are not bothered by disturbing background noises.

### Strong and stable

The heavy-duty thick material ensures reliable use in rough environments. The high weight of 4.7 kg complements the appearance of a maximally stable solution. All components are designed for heavy loading. Up to 200 kg of drag and compressive forces of the wind can be absorbed. This has been tested at the MAY factory.

### The Material

The telescopic bars are made from aluminium. The surfaces are EV1 anodized and extremely shock and impact resistant.

### Centre pole extension / centre pole shortening

The telescoping mechanism allows a "headroom without valance" (measure D, see MAY catalogue commercial parasols) of minimum 165 cm and maximum 285 cm. Therefore, the standard measure as well as extensions up to 40 cm are easily realized. Only in case of extreme centre pole extensions, "upper tubes with extensions" are required.







SCHATTELLO 4.0 x 4.0 m  
MayTex-Acryl SA 314 347 ruby

The screw-in ground anchor has proven ideal for state-of-the-art foundations. No digging, no concreting necessary. Below: a chart showing that ground-screw installation is more time and cost efficient than concreting

Concreting	Ground screw installation
Installation workers have to make two journeys because of waiting time for concrete to cure.	Just one person comes to take a soil sample. The next time, the screw-in ground anchor is installed. No installation waiting-time.
concrete, gravel and water needed.	only the ground screw needed.
soil excavation necessary.	installed with a special groundscrew driver.
costs of excavation and disposal of spoil.	soil is only shaken up and shifted somewhat.
cannot be relocated.	relocation possible.
surrounding area spoiled by excavation work.	surrounding area remains unspoiled.
weather-dependent.	installation possible even in frosty ground.

## Screw-in ground anchor

Basically, the installation system consists of two components: the screw-in ground anchor and the parasol upper anchor tube.



upper part



screw-in ground anchor

### Function

The ground screw is driven vertically down into the ground until the flange plate is absolutely level with the ground. Due to the conical shape of the shaft, the soil is compressed, providing maximum stability and security. With the help of a Krinner driver, screw-in anchors can be installed into ground up to soil class 4. Special installation machinery may be necessary for higher soil classes.

### Upper anchor tube

The upper anchor tube is fastened to the flange plate of the ground screw with three screws. By means of three adjusting screws the parasol pole is aligned into an upright position.

### Environmentally-friendly

The entire surroundings remain unspoiled and in original condition, so there is no surface area coverage.

### Statics test

To eliminate any risks, parasols installed with screw-in ground anchors and upper anchor tubes have been static-tested for use in soil classes 3-7 and windforce 4.

### Preparatory measures

Before placing your order, please make sure that there are no gas, water, power or other supply lines in the vicinity of the designated spot for the ground screw that could be damaged during installation. Customers are required in advance to declare their own responsibility and liability concerning this matter in writing.

### Installation machinery

For information and services concerning installation machinery for screw-in ground anchors please contact one of the "Krinner Groundscrew" trade partners at: [www.krinner.com](http://www.krinner.com) You will require the following Krinner attachment: Z1 Attachment F 1234567.

A company employee will first pay an on-site visit to take a soil sample. This will determine whether your screw-in ground anchor can be installed with a groundscrew driver or if special installation machinery is needed. Installation costs will depend on the services required.



## Ground screw installation in 5 steps



### 1. Soil removal and pre-drilling

Remove any paving and gravel to a depth of approx. 15 cm. Using a 40 mm drill, pre-drill vertically into the designated installation spot.



### 2. Preparation

In preparation for the 2.1 m screw-in ground anchor, a smaller, approx. 1.2 m screw must be driven into the ground and then removed again.



### 3. Installation

Drive the 2.1 m ground screw into the pre-drilled hole until it is flush with the ground. If several parasols are to be installed, use a levelling instrument to make sure that all ground screws are flush.

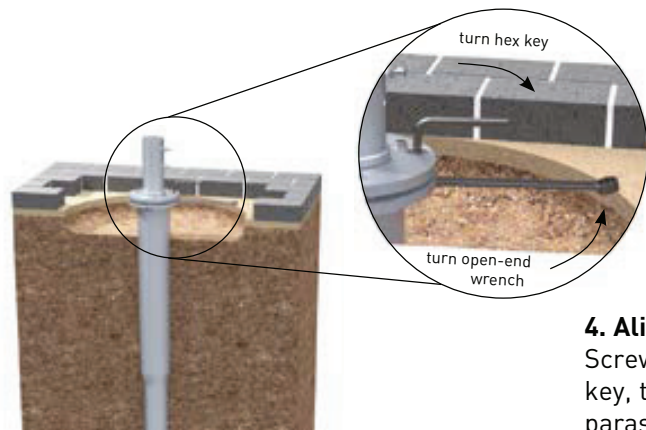

### 4. Aligning

Screw on the upper anchor tube with an open-end wrench and hex key, then align vertically with adjusting screws so that the mounted parasol is upright.



### 5. Final step

Fill up with gravel and lay paving stones right close to the flange plate so that the ground screw itself becomes invisible.



FILIUS FS 3.0 x 3.0 m, MayTex-Acryl 314 010 white, National Garden Show in Koblenz





3-D visualisation



SCHATTELLO 4.0 x 4.0 m  
cloth: MayTex-Poly  
fabric and colour: M 9875 creme  
without valance

### Add on benefits to your parasol

Decide for a successful local marketing. With printings on the valances you reach the eye level of your customers. Large, eye-catching motives can be placed onto the canopy. You decide if they are legible from above or from below.

A printed protection sleeve provides a perfect advertising space that achieves a powerful marketing even in the off-season when the parasol is closed. We will be happy to assist you – from the first sketch to the expressive final product.



### MAY Printing Guidelines



For more information see the brochure „Printing guidelines“. Please download this under: [www.may.ag/orderform\\_F.pdf](http://www.may.ag/orderform_F.pdf) or scan the QR code.

Art. no. **355799**







## CONTACT US



**ShadeZone**  
Alfresco Specialists

The S Zone UK Limited, Unit B4 -B5 Citadel Trading Estate,  
Citadel Way, Hull, HU9 1TQ. United Kingdom

Telephone: +44 (0)1482 219919 | Email: [info@s-zone.co.uk](mailto:info@s-zone.co.uk)  
[www.shadezone.co.uk](http://www.shadezone.co.uk)

For further information we will be happy to assist you.

**MAY Geraetebau GmbH**

Zum Mühlbach 1  
88422 Betzenweiler, Germany

[info@may-online.com](mailto:info@may-online.com)  
[www.may-online.com](http://www.may-online.com)

Management directors:  
Karl-Heinz May, Klaus-Peter May  
Court Register Ulm HRB 650155